

Makita

アメリカ

Drills

13 mm (1/2") MODEL 6013B
13 mm (1/2") MODEL 6013BR — Reversing —

INSTRUCTION MANUAL

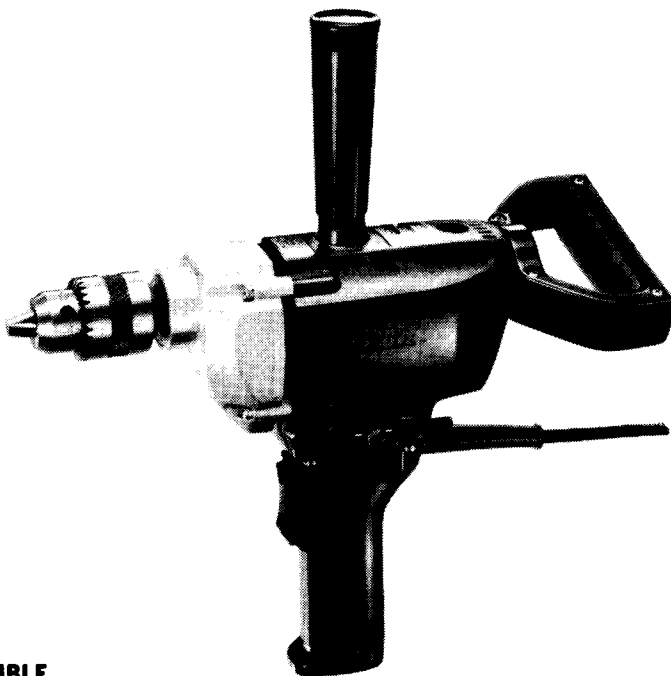

**DOUBLE
INSULATION**

SPECIFICATIONS

MODEL	Drilling capacities		Continuous rating		No load speed	Overall length	Net weight	Power supply cord
	Steel	Wood	Input	Output				
6013B	13 mm (1/2")	36 mm (1-3/8")	650 W	430 W	550 R/min.	340 mm (13-3/8")	2.8 kg (6.2 lbs)	2.5 m (8.2 ft.)
6013BR			620 W	360 W				

* Manufacturer reserves the right to change specifications of parts and accessories without notice.

* Note: Specifications of parts and accessories may differ from country to country.

IMPORTANT SAFETY INSTRUCTIONS

(For All Tools)

WARNING: WHEN USING ELECTRIC TOOLS, BASIC SAFETY PRECAUTIONS SHOULD ALWAYS BE FOLLOWED TO REDUCE THE RISK OF FIRE, ELECTRIC SHOCK, AND PERSONAL INJURY, INCLUDING THE FOLLOWING:

READ ALL INSTRUCTIONS.

- 1. KEEP WORK AREA CLEAN.** Cluttered areas and benches invite injuries.
- 2. CONSIDER WORK AREA ENVIRONMENT.** Don't use power tools in damp or wet locations. Keep work area well lit. Don't expose power tools to rain. Don't use tool in presence of flammable liquids or gases.
- 3. KEEP CHILDREN AWAY.** All visitors should be kept away from work area. Don't let visitors contact tool or extension cord.
- 4. STORE IDLE TOOLS.** When not in use, tools should be stored in dry, and high or locked-up place — out of reach of children.
- 5. DON'T FORCE TOOL.** It will do the job better and safer at the rate for which it was intended.
- 6. USE RIGHT TOOL.** Don't force small tool or attachment to do the job of a heavy-duty tool. Don't use tool for purpose not intended.
- 7. DRESS PROPERLY.** Don't wear loose clothing or jewelry. They can be caught in moving parts. Rubber gloves and non-skid footwear are recommended when working outdoors. Wear protective hair covering to contain long hair.
- 8. USE SAFETY GLASSES.** Also use face or dust mask if cutting operation is dusty.
- 9. DON'T ABUSE CORD.** Never carry tool by cord or yank it to disconnect from receptacle. Keep cord from heat, oil, and sharp edges.
- 10. SECURE WORK.** Use clamps or a vise to hold work. It's safer than using your hand and it frees both hands to operate tool.
- 11. DON'T OVERREACH.** Keep proper footing and balance at all times.
- 12. MAINTAIN TOOLS WITH CARE.** Keep tools sharp and clean for better and safer performance. Follow instructions for lubricating and changing accessories. Inspect tool cords periodically and if damaged, have repaired by authorized service facility. Inspect extension cords periodically and replace if damaged. Keep handles dry, clean, and free from oil and grease.
- 13. DISCONNECT TOOLS.** When not in use, before servicing, and when changing accessories, such as blades, bits, cutters.

14. **REMOVE ADJUSTING KEYS AND WRENCHES.** Form habit of checking to see that keys and adjusting wrenches are removed from tool before turning it on.
15. **AVOID UNINTENTIONAL STARTING.** Don't carry plugged-in tool with finger on switch. Be sure switch is OFF when plugging in.
16. **OUTDOOR USE EXTENSION CORDS.** When tool is used outdoors, use only extension cords intended for use outdoors and so marked.
17. **STAY ALERT.** Watch what you are doing, use common sense. Don't operate tool when you are tired.
18. **CHECK DAMAGED PARTS.** Before further use of the tool, a guard or other part that is damaged should be carefully checked to determine that it will operate properly and perform its intended function. Check for alignment of moving parts, binding of moving parts, breakage of parts, mounting, and any other conditions that may affect its operation. A guard or other part that is damaged should be properly repaired or replaced by an authorized service center unless otherwise indicated elsewhere in this instruction manual. Have defective switches replaced by authorized service center. Don't use tool if switch does not turn it on and off.
19. **GUARD AGAINST ELECTRIC SHOCK.** Prevent body contact with grounded surfaces. For example; pipes, radiators, ranges, refrigerator enclosures.
20. **REPLACEMENT PARTS.** When servicing, use only identical replacement parts.
21. **POLARIZED PLUGS.** To reduce the risk of electric shock, this equipment has a polarized plug (one blade is wider than the other). This plug will fit in a polarized outlet only one way. If the plug does not fit fully in the outlet, reverse the plug. If it still does not fit, contact a qualified electrician to install the proper outlet. Do not change the plug in any way.

VOLTAGE WARNING: Before connecting the tool to a power source (receptacle, outlet, etc.) be sure the voltage supplied is the same as that specified on the nameplate of the tool. A power source with voltage greater than that specified for the tool can result in **SERIOUS INJURY** to the user — as well as damage to the tool. If in doubt, **DO NOT PLUG IN THE TOOL.** Using a power source with voltage less than the nameplate rating is harmful to the motor.

SAVE THESE INSTRUCTIONS.

Drill & Standard Equipment

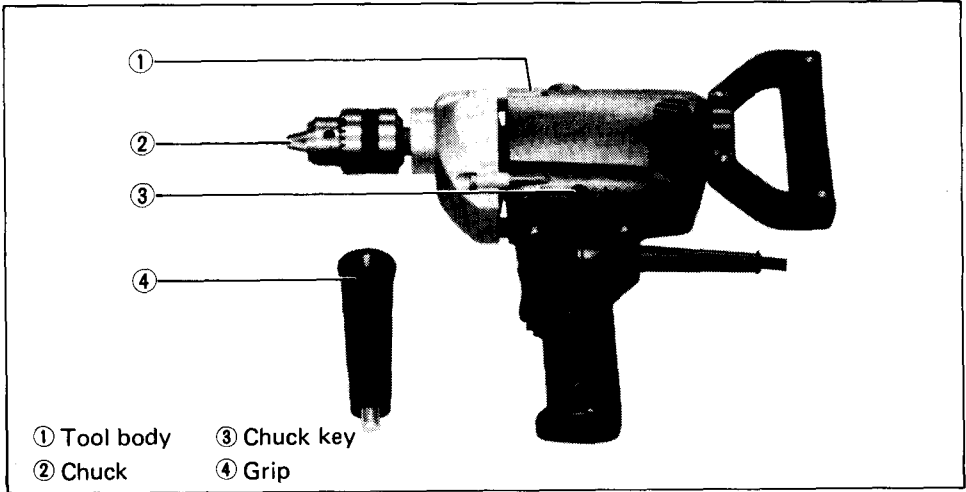

How to use

• Chuck

When installing a drill bit with the chuck key, notice that there are three holes in the chuck where the bit should be tightened, not just one. Tighten evenly at all three holes in order. (as you would mount a tire).

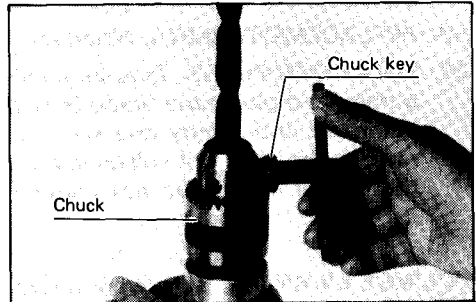

● **Drilling in wood**

In drilling holes in wood using a wood drill with a guide screw, there is no need to bear down on the tool. The guide screw makes it bore naturally by itself.

● **Drilling in metal**

In general, use a cutting lubricant when drilling metal. (But not with iron or brass).

● **Switch action**

* **Model 6013B:**

To start the tool, simply pull the trigger. Release the trigger to stop. For continuous operation without having to keep your finger on the trigger, just pull the trigger and then push in the lock button with your thumb. To stop the tool from the lock position, simply pull the trigger again and release it.

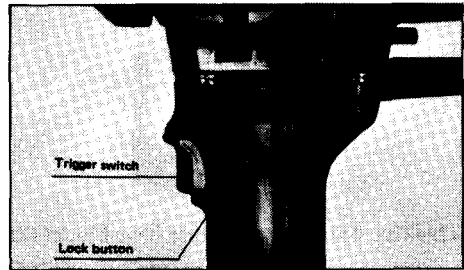

* **Model 6013BR,**

The switch is reversible, providing either clockwise or counterclockwise rotation. Pulling the lower part of the trigger puts the wrench on in the clockwise direction. Pulling the upper part of the trigger puts the tool on in the counterclockwise direction. Simply releasing either end of the trigger turns the tool off.

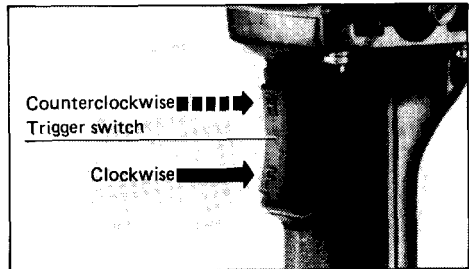

Warning: It is dangerous and injurious to the tool to reverse the rotation by rapid switching without waiting for the motor to stop. Put the tool off, then wait for complete stop before switching direction of rotation.

MAINTENANCE

● **Carbon brushes**

Replace carbon brushes when they wear down to about 5 mm (3/16") or sparking will occur. Both brushes should be changed at the same time.

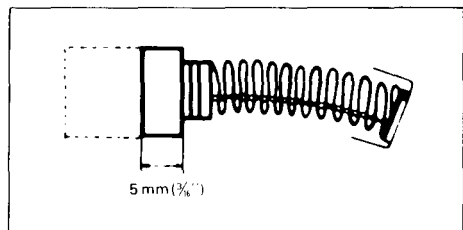

Optional Accessories CAUTION: The use of any other accessories not specified in this manual might be hazardous.

- **TYPE 43 Bench Drill Stand** Part No. 122190-0 (For Model 6013B)

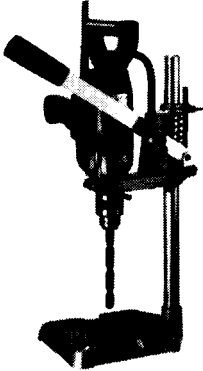

- **Makita Angle Attachment (For Model 6013B)**
(Ideal for drilling in tight corners or difficult access area).

Part No. 122177-2

Angle



Joint



Sleeve



Wrench



- **Depth Rod Assembly**

Part No. 122236-2



13 mm (1/2") DRILL Model 6013BR

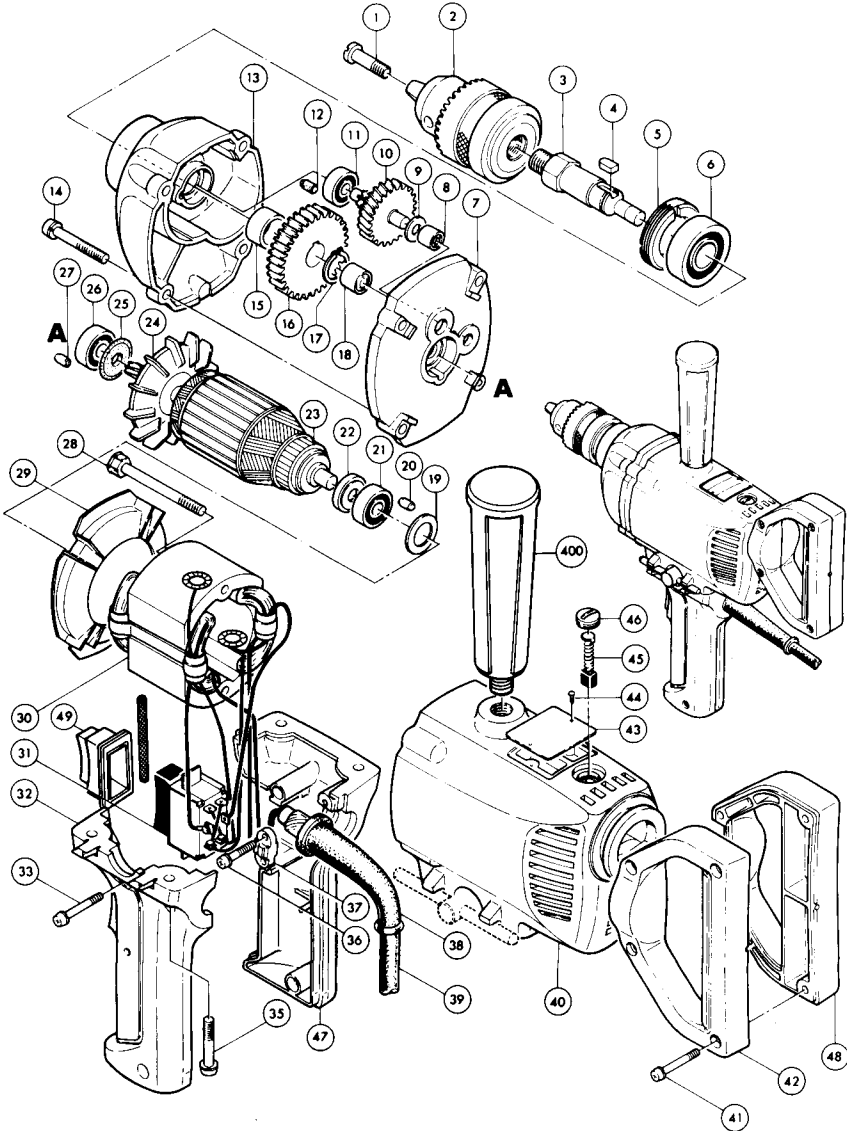

Note: The switch and other part configurations may differ from country to country.

ITEM NO.	NO. USED	DESCRIPTION	ITEM NO.	NO. USED	DESCRIPTION
MACHINE			MACHINE		
1	1	Flat Head Screw M6x22	27	1	Rubber Pin 4
2	1	Drill Chuck S13	28	2	Hex. Bolt M5x55 (With Washer)
3	1	Spindle	29	1	Baffle Plate
4	1	Key 5	30	1	FIELD ASSEMBLY
5	1	Bearing Retainer 25-36	31	1	Switch
6	1	Ball Bearing 6202LLB	32	1	Switch Handle Cover Set (With Item 47)
7	1	Gear Housing Cover	33	2	Pan Head Screw M4x28 (With Washer)
8	1	Needle Bearing 609	35	4	Pan Head Screw M5x28 (With Washer)
9	1	Fiber Washer 6	36	2	Pan Head Screw M4x18 (With Washer)
10	1	Gear Complete 7-41	37	1	Strain Relief
11	1	Ball Bearing 626LLB	38	1	Cord Guard
12	1	Rubber Pin 4	39	1	CORD ASSEMBLY (Assembled Cord, Plug & Item 38)
13	1	Gear Housing	40	1	Motor Housing
14	4	Pan Head Screw M5x35 (With Washer)	41	4	Pan Head Screw M4x28 (With Washer)
15	1	Ring 15	42	1	Handle Set (With Item 48)
16	1	Spur Gear 47	43	1	Name Plate
17	1	Retaining Ring S-14	44	2	Rivet 0-5
18	1	Needle Bearing 810	45	2	Carbon Brush
19	1	Flat Washer 14	46	2	Brush Holder Cap
20	1	Rubber Pin 4	47	1	Switch Handle Cover Set (With Item 32)
21	1	Ball Bearing 608LB	48	1	Handle Set (With Item 42)
22	1	Insulation Washer	49	1	Dust Cover
23	1	ARMATURE ASSEMBLY (With Item 21 - 26)	400	1	Grip 37
24	1	Fan 62			
25	1	Dust Seal 8			
26	1	Ball Bearing 608LLB			

Note: The switch and other part specifications may differ from country to country.

MAKITA LIMITED ONE YEAR WARRANTY

Warranty Policy

Every Makita tool is thoroughly inspected and tested before leaving the factory. It is warranted to be free of defects from workmanship and materials for the period of ONE YEAR from the date of original purchase. Should any trouble develop during this one-year period, return the COMPLETE tool, freight prepaid, to one of Makita's Factory or Authorized Service Centers. If inspection shows the trouble is caused by defective workmanship or material, Makita will repair (or at our option, replace) without charge.

This Warranty does not apply where:

- repairs have been made or attempted by others;
- repairs are required because of normal wear and tear;
- The tool has been abused, misused or improperly maintained;
- alterations have been made to the tool.

IN NO EVENT SHALL MAKITA BE LIABLE FOR ANY INDIRECT, INCIDENTAL OR CONSEQUENTIAL DAMAGES FROM THE SALE OR USE OF THE PRODUCT. THIS DISCLAIMER APPLIES BOTH DURING AND AFTER THE TERM OF THIS WARRANTY.

MAKITA DISCLAIMS LIABILITY FOR ANY IMPLIED WARRANTIES, INCLUDING IMPLIED WARRANTIES OF "MERCHANTABILITY" AND "FITNESS FOR A SPECIFIC PURPOSE," AFTER THE ONE-YEAR TERM OF THIS WARRANTY.

This Warranty gives you specific legal rights, and you may also have other rights which vary from state to state. Some states do not allow the exclusion or limitation of incidental or consequential damages, so the above limitation or exclusion may not apply to you. Some states do not allow limitation on how long an implied warranty lasts, so the above limitation may not apply to you.

Makita Corporation

3-11-8, Sumiyoshi-cho,
Anjo, Aichi 446 Japan

883096A066

PRINTED IN JAPAN
1992 — 8 — N