

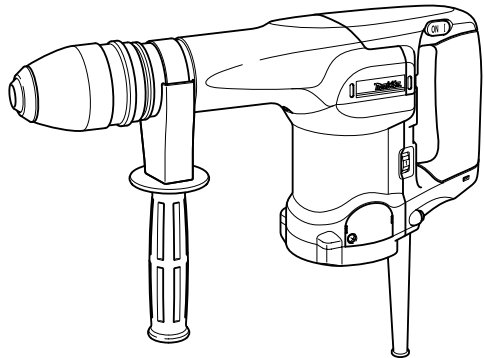

# Demolition Hammer

MODEL HM0860C



004479



## INSTRUCTION MANUAL

**⚠ WARNING:**

For your personal safety, READ and UNDERSTAND before using.  
SAVE THESE INSTRUCTIONS FOR FUTURE REFERENCE.

[www.makitatools.com](http://www.makitatools.com)

---

## SPECIFICATIONS

Model	HM0860C
Blows per minute	1,100 - 2,650
Overall length	454 mm (17-7/8")
Net weight	4.7 kg (10.4 lbs)

- Manufacturer reserves the right to change specifications without notice.
- Specifications may differ from country to country.

---

## GENERAL SAFETY RULES

USA002-2

(For All Tools)

### **WARNING:**

**Read and understand all instructions.** Failure to follow all instructions listed below, may result in electric shock, fire and/or serious personal injury.

---

## SAVE THESE INSTRUCTIONS

### Work Area

1. **Keep your work area clean and well lit.** Cluttered benches and dark areas invite accidents.
2. **Do not operate power tools in explosive atmospheres, such as in the presence of flammable liquids, gases, or dust.** Power tools create sparks which may ignite the dust or fumes.
3. **Keep bystanders, children, and visitors away while operating a power tool.** Distractions can cause you to lose control.

### Electrical Safety

4. **Double insulated tools are equipped with a polarized plug (one blade is wider than the other.) This plug will fit in a polarized outlet only one way. If the plug does not fit fully in the outlet, reverse the plug. If it still does not fit, contact a qualified electrician to install a polarized outlet. Do not change the plug in any way.** Double insulation  eliminates the need for the three wire grounded power cord and grounded power supply system.
5. **Avoid body contact with grounded surfaces such as pipes, radiators, ranges and refrigerators.** There is an increased risk of electric shock if your body is grounded.

6. **Do not expose power tools to rain or wet conditions.** Water entering a power tool will increase the risk of electric shock.
7. **Do not abuse the cord. Never use the cord to carry the tools or pull the plug from an outlet. Keep cord away from heat, oil, sharp edges or moving parts. Replace damaged cords immediately.** Damaged cords increase the risk of electric shock.
8. **When operating a power tool outside, use an outdoor extension cord marked “W-A” or “W”.** These cords are rated for outdoor use and reduce the risk of electric shock.

## Personal Safety

9. **Stay alert, watch what you are doing and use common sense when operating a power tool. Do not use tool while tired or under the influence of drugs, alcohol, or medication.** A moment of inattention while operating power tools may result in serious personal injury.
10. **Dress properly. Do not wear loose clothing or jewelry. Contain long hair. Keep your hair, clothing, and gloves away from moving parts.** Loose clothes, jewelry, or long hair can be caught in moving parts.
11. **Avoid accidental starting. Be sure switch is off before plugging in.** Carrying tools with your finger on the switch or plugging in tools that have the switch on invites accidents.
12. **Remove adjusting keys or wrenches before turning the tool on.** A wrench or a key that is left attached to a rotating part of the tool may result in personal injury.
13. **Do not overreach. Keep proper footing and balance at all times.** Proper footing and balance enables better control of the tool in unexpected situations.
14. **Use safety equipment. Always wear eye protection.** Dust mask, non-skid safety shoes, hard hat, or hearing protection must be used for appropriate conditions. Ordinary eye or sun glasses are NOT eye protection.

## Tool Use and Care

15. **Use clamps or other practical way to secure and support the workpiece to a stable platform.** Holding the work by hand or against your body is unstable and may lead to loss of control.
16. **Do not force tool. Use the correct tool for your application.** The correct tool will do the job better and safer at the rate for which it is designed.
17. **Do not use tool if switch does not turn it on or off.** Any tool that cannot be controlled with the switch is dangerous and must be repaired.
18. **Disconnect the plug from the power source before making any adjustments, changing accessories, or storing the tool.** Such preventive safety measures reduce the risk of starting the tool accidentally.
19. **Store idle tools out of reach of children and other untrained persons.** Tools are dangerous in the hands of untrained users.
20. **Maintain tools with care. Keep cutting tools sharp and clean.** Properly maintained tools with sharp cutting edges are less likely to bind and are easier to control.
21. **Check for misalignment or binding of moving parts, breakage of parts, and any other condition that may affect the tools operation. If damaged, have the tool serviced before using.** Many accidents are caused by poorly maintained tools.
22. **Use only accessories that are recommended by the manufacturer for your model.** Accessories that may be suitable for one tool, may become hazardous when used on another tool.

## SERVICE

23. **Tool service must be performed only by qualified repair personnel.** Service or maintenance performed by unqualified personnel could result in a risk of injury.

**24. When servicing a tool, use only identical replacement parts. Follow instructions in the Maintenance section of this manual.**

Use of unauthorized parts or failure to follow Maintenance instructions may create a risk of electric shock or injury.

**USE PROPER EXTENSION CORD:** Make sure your extension cord is in good condition. When using an extension cord, be sure to use one heavy enough to carry the current your product will draw. An undersized cord will cause a drop in line voltage resulting in loss of power and overheating. Table 1 shows the correct size to use depending on cord length and nameplate ampere rating. If in doubt, use the next heavier gage. The smaller the gage number, the heavier the cord.

**Table 1: Minimum gage for cord**

Ampere Rating		Volts	Total length of cord in feet			
		120 V	25 ft.	50 ft.	100 ft.	150 ft.
More Than	Not More Than	AWG				
0	6		18	16	16	14
6	10		18	16	14	12
10	12		16	16	14	12
12	16		14	12	Not Recommended	

## SPECIFIC SAFETY RULES

USB009-2

**DO NOT let comfort or familiarity with product (gained from repeated use) replace strict adherence to hammer safety rules. If you use this tool unsafely or incorrectly, you can suffer serious personal injury.**

1. Hold tools by insulated gripping surfaces when performing an operation where the cutting tool may contact hidden wiring or its own cord. Contact with a “live” wire will make exposed metal parts of the tool “live” and shock the operator.
2. Wear ear protectors when using the tool for extended periods. Prolonged exposure to high intensity noise can cause hearing loss.
3. Wear a hard hat (safety helmet), safety glasses and/or face shield. Ordinary eye or sun glasses are NOT safety glasses. It is also highly recommended that you wear a dust mask and thickly padded gloves.
4. Be sure the bit is secured in place before operation.
5. Under normal operation, the tool is designed to produce vibration. The screws can come loose easily, causing a breakdown or accident. Check tightness of screws carefully before operation.
6. In cold weather or when the tool has not been used for a long time, let the tool warm up for a while by operating it under no load. This will loosen up the lubrica-

- 
- tion. Without proper warm-up, hammering operation is difficult.
7. Always be sure you have a firm footing. Be sure no one is below when using the tool in high locations.
  8. Hold the tool firmly with both hands.
  9. Keep hands away from moving parts.
  10. Do not leave the tool running. Operate the tool only when hand-held.
  11. Do not point the tool at any one in the area when operating. The bit could fly out and injure someone seriously.
  12. Do not touch the bit or parts close to the bit immediately after operation; they may be extremely hot and could burn your skin.
  13. Some material contains chemicals which may be toxic. Take caution to prevent dust inhalation and skin contact. Follow material supplier safety data.
- 

## SAVE THESE INSTRUCTIONS



**⚠ WARNING:**  
**MISUSE** or failure to follow the safety rules stated in this instruction manual may cause serious personal injury.

---

## SYMBOLS

USD203-2

The followings show the symbols used for tool.

- |  |                     |   |   |
|--|---------------------|---|---|
| V .....  | volts               |  ..... | Class II Construction                   |
| A .....  | amperes             | .../min.....  | revolutions or reciprocation per minute |
| Hz .....   | hertz               |  ..... | number of blow                          |
|  ..... | alternating current |   |   |

# FUNCTIONAL DESCRIPTION

**⚠ CAUTION:**

- Always be sure that the tool is switched off and unplugged before adjusting or checking function on the tool.

## Switch action

**⚠ CAUTION:**

- Before plugging in the tool, always check to see that the tool is switched off.

To start the tool, push the “I (ON)” side of the switch lever. To stop the tool, push the “O (OFF)” side of the switch lever.

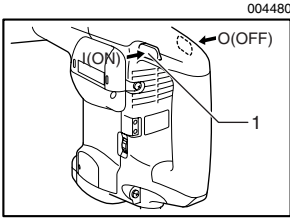

1. Switch lever

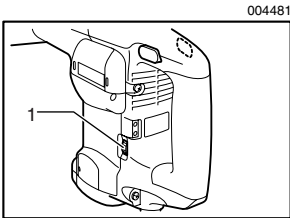

1. Adjusting dial

## Speed change

The blows per minute can be adjusted just by turning the adjusting dial. This can be done even while the tool is running. The dial is marked 1 (lowest speed) to 5 (full speed).

Refer to the table below for the relationship between the number settings on the adjusting dial and the blows per minute.

C00148

Number on adjusting dial	Blows per minute
5	2,650
4	2,450
3	1,900
2	1,350
1	1,100

**⚠ CAUTION:**

- The speed adjusting dial can be turned only as far as 5 and back to 1. Do not force it past 5 or 1, or the speed adjusting function may no longer work.

004482

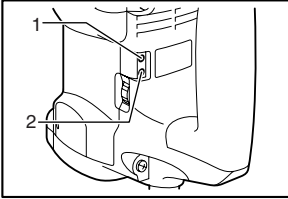

1. Power-ON indicator lamp ( green)
2. Service indicator lamp ( red )

## Indicator lamp

The green power-ON indicator lamp lights up when the tool is plugged. The indicator lamp is lit but the tool does not start even if the tool is switched on, the carbon brushes may be worn out, or the electric circuit or the motor may be defective. If the indicator lamp does not light up and the tool does not start, the ON/OFF switch or the mains cord may be defective.

The red service indicator lamp lights up when the carbon brushes are nearly worn out to indicate that the tool needs servicing. After approx. 8 hours of use, the motor will automatically be shut off.

## ASSEMBLY

### ⚠ CAUTION:

- Always be sure that the tool is switched off and unplugged before carrying out any work on the tool.

004483

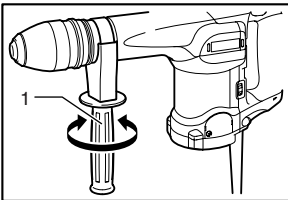

1. Side grip

## Side grip (auxiliary handle)

The side grip swings around to either side, allowing easy handling of the tool in any position. Loosen the side grip by turning it counterclockwise, swing it to the desired position and then tighten it by turning clockwise.

## Bit grease (optional accessory)

Coat the bit shank head beforehand with a small amount of bit grease (about 0.5 -1 g;.). This chuck lubrication assures smooth action and longer service life.

003150

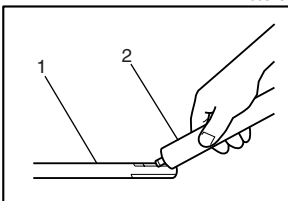

1. Bit shank
2. Bit grease

## Installing or removing the bit

Clean the bit shank and apply bit grease before installing the bit.

004484

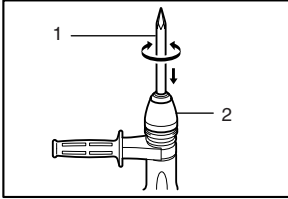

1. Bit
2. Chuck cover

Insert the bit into the tool. Turn the bit and push it in until it engages.

If the bit cannot be pushed in, remove the bit. Pull the chuck cover down a couple of times. Then insert the bit again. Turn the bit and push it in until it engages.

After installing, always make sure that the bit is securely held in place by trying to pull it out.

004485

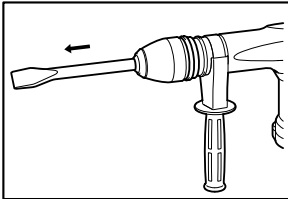

To remove the bit, pull the chuck cover down all the way and pull the bit out.

004486

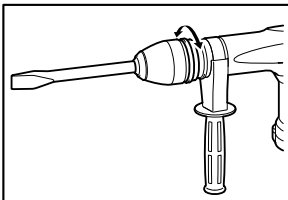

### Bit angle

The bit can be secured at 12 different angles. To change the bit angle, slide the change ring forward, then turn the change ring to change the bit angle. At the desired angle, slide the change ring back to the original position. The bit will be secured in place.

## OPERATION

### ⚠ CAUTION:

- Always use the side grip (auxiliary handle) and firmly hold the tool by both side grip and switch handle during operations.

004487

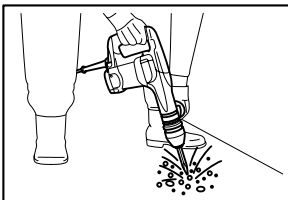

### Chipping/Scaling/Demolition

Hold the tool firmly with both hands. Turn the tool on and apply slight pressure on the tool so that the tool will not bounce around, uncontrolled. Pressing very hard on the tool will not increase the efficiency.



# MAINTENANCE

## ⚠ CAUTION:

- Always be sure that the tool is switched off and unplugged before attempting to perform inspection or maintenance.

## Replacing carbon brushes

When the resin insulating tip inside the carbon brush is exposed to contact the commutator, it will automatically shut off the motor. When this occurs, both carbon brushes should be replaced. Keep the carbon brushes clean and free to slip in the holders. Both carbon brushes should be replaced at the same time. Use only identical carbon brushes.

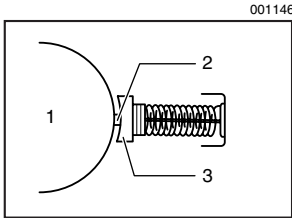

1. Commutator
2. Insulating tip
3. Carbon brush

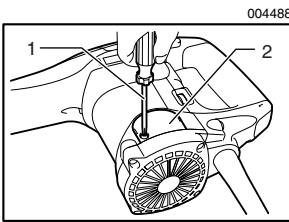

1. Screwdriver
2. Brush holder cover

Use a screwdriver to remove the brush holder covers.

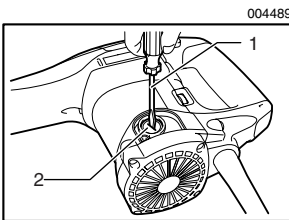

1. Screwdriver
2. Brush holder cap

Use a screwdriver to remove the brush holder caps. Take out the worn carbon brushes, insert the new ones and secure the brush holder caps.

Reinstall the brush holder covers firmly.

## Lubrication

This tool requires no hourly or daily lubrication because it has a grease-packed lubrication system. It should be relubricated after every 6 months of operation. Send the complete tool to Makita Authorized Service Center for this lubrication service. However, if circumstances require that you should lubricate it by yourself, proceed as follows.

Run the tool for several minutes to warm it up. Switch off and unplug the tool.

Loosen the four screws (two short screws on the upper side and two long screws on the lower side. ) and remove the handle.

Disconnect the terminal by pulling it.

Remove the crank cap by loosening the screws with a screwdriver. Rest the tool on the table with the bit end pointing upwards. This will allow the old grease to collect inside the crank housing.

Wipe out the old grease inside and replace with a fresh grease (30 g). Use only Makita genuine hammer grease (optional accessory). Filling with more than the specified amount of grease (approx. 30 g) can cause faulty hammering action or tool failure. Fill only with the specified amount of grease.

Reinstall the crank cap and secure with the screws.

004490

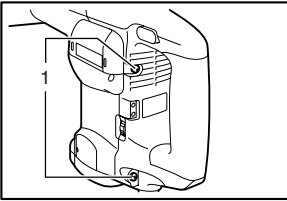

1. Screw

004491

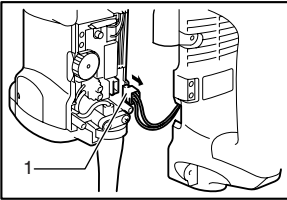

1. Terminal

004492

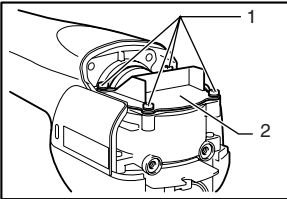

1. Screw

2. Crank cap

004493

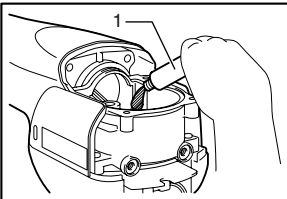

1. Hammer grease

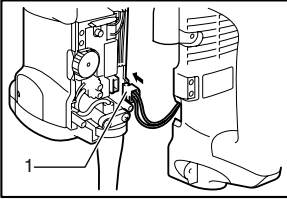

1. Terminal

Connect the terminal and reinstall the handle.

**⚠ CAUTION:**

- Be careful not to damage the terminal or lead wires especially when wiping out the old grease or installing the handle.
- Whenever reinstalling the handle, use the two short screws for the upper side and two long screws for the lower side.

To maintain product SAFETY and RELIABILITY, repairs, any other maintenance or adjustment should be performed by Makita Authorized or Factory Service Centers, always using Makita replacement parts.

## ACCESSORIES

**⚠ CAUTION:**

- These accessories or attachments are recommended for use with your Makita tool specified in this manual. The use of any other accessories or attachments might present a risk of injury to persons. Only use accessory or attachment for its stated purpose.

If you need any assistance for more details regarding these accessories, ask your local Makita service center.

- Bull point
- Cold chisel
- Scaling chisel
- Grooving chisel
- Clay spade
- Bit grease
- Rammer
- Bushing tool
- Ground rod adapter
- Hammer grease
- Safety goggle
- Side handle (auxiliary handle)



**Memo**

---

---

---

---

---

---

---

---

---

---

---

---

---

---

---

---

---

---

---

---

---

---

---

---

---

Cut



First-Class  
Postage  
Required

Post Office will  
not deliver  
without proper  
postage.

**Makita U.S.A., Inc.**  
14930 Northam Street  
La Mirada, CA 90638-5753



Fold

# MAIL THIS PORTION

Your answers to the following questions are appreciated.

**1. This product was purchased from:**

- Home Center       Other (            )  
 Hardware/Lumber Store  
 Tool Distributor  
 Industrial Supply  
 Construction Supply

**3. How did you learn about this product:**

- Magazine       Radio  
 From Dealer       Exhibition  
 Newspaper       From Friend  
 Store Display       Previous Usage  
 Catalog       Other (            )

**2. Use of the product is intended for:**

- Construction Trade  
 Industrial Maintenance  
 Home Maintenance  
 Hobby  
 Other (            )

**4. Most favored points are:**

- Design       Repair Service  
 Features       Durability  
 Size       Power  
 Price       Other (            )  
 Makita Brand

**5. Any comments:**

---



---



---



---

DATE PURCHASED			MODEL NO.														
MONTH		DAY		YEAR		SERIAL NO.											
INTL.	LAST NAME / COMPANY NAME											STATUS		SEX			
												Married	Single	M	F		
STREET ADDRESS																	
CITY																	
STATE		ZIP CODE				PHONE				AREA CODE							
AGE:		<input type="checkbox"/> Under 19		<input type="checkbox"/> 20-29		<input type="checkbox"/> 30-39		<input type="checkbox"/> 40-49		<input type="checkbox"/> 50-60		<input type="checkbox"/> Over 60					

BE SURE TO COMPLETE THE CUSTOMER'S PORTION OF THIS FORM AND RETAIN FOR YOUR RECORDS.

Please return this portion by facsimile or mail.

Facsimile No: (714) 522-8133

# FACTORY SERVICE CENTERS

1-800-4-MAKITA

RETAIN THIS PORTION FOR YOUR RECORDS

**ARIZONA**

3707 E. Broadway Rd., Ste. 6  
Phoenix, AZ 85040  
(602) 437-2850

**CALIFORNIA**

41850 Christy St.  
Fremont, CA 94538-5107  
(510) 657-9881

14930 Northam St.  
La Mirada, CA 90638-5753  
(714) 522-8088

1970 Fulton Avenue  
Sacramento, CA 95825  
(916) 482-5197

7674 Clairemont Mesa Blvd.  
San Diego, CA 92111  
(858) 278-4471

16735 Saticoy St., Ste. 105  
Van Nuys, CA 91406  
(818) 782-2440

**COLORADO**

11839 E. 51st Ave.  
Denver, CO 80239-2709  
(303) 371-2850

**FLORIDA**

750 East Sample Road  
Pompano Beach, FL 33064  
(954) 781-6333

**GEORGIA**

4680 River Green Parkway NW  
Duluth, GA 30096  
(770) 476-8911

**ILLINOIS**

1450 Feehanville Dr.  
Mt. Prospect, IL 60056-6011  
(847) 297-3100

**MARYLAND**

7397 Washington Boulevard,  
Suite 104 Elkridge, MD 21075  
(410) 476-4401

**MASSACHUSETTS**

232 Providence Hwy.  
Westwood, MA 02090  
(781) 461-9754

**MINNESOTA**

6427 Penn Ave. South  
Richfield, MN 55423  
(612) 869-5199

**MISSOURI**

9876 Watson Road  
St. Louis, MO 63126-2221  
(314) 909-9889

**NEBRASKA**

4129 S. 84th St.  
Omaha, NE 68127  
(402) 597-2925

**NEVADA**

3375 S. Decatur Blvd.  
Suites. 22 - 24  
Las Vegas, NV 89102  
(702) 368-4277

**NEW JERSEY**

251 Herrod Blvd.  
Dayton, NJ 08810-1539  
(609) 655-1212

**NEW YORK**

4917 Genessee Street  
Cheektowaga, NY 14225  
(716) 685-9503

**OREGON**

828 19th Avenue, N.W.  
Portland, OR 97209  
(503) 222-1823

**PENNSYLVANIA**

1704 Babcock Blvd.  
Pittsburgh, PA 15209  
(412) 822-7370

**PUERTO RICO**

200 Guayama St.  
Hato Rey, PR 00917  
(787) 250-8776

**TENNESSEE**

1120 Elm Hill P.  
Suite 170 Nashville, TN 372  
(615) 248-3321

**TEXAS**

12801 Stemmons Fwy Ste. 809  
Farmers Branch, TX 75234  
(972) 243-1150

12701 Directors Dr.  
Stafford, TX 77477-3701  
(281) 565-8665

3453 IH-35 North, Ste. 101  
San Antonio, TX 78219  
(210) 228-0676

**WISCONSIN**

Lincoln Plaza Shopping Ctr.  
2245 S. 108th St. West Allis, WI  
53227  
(414) 541-4776

**CUSTOMER'S RECORD**

<p><b>When you need service:</b> Send complete tool (prepaid) to one of the Makita Factory Service Centers listed, or to an Authorized Makita Service Center. Be sure to attach a letter to the outside of the carton detailing the problem with your tool.</p>	Date Purchased
	Dealer's Name & Address
	Model No.
	Serial No.

# WARNING

Some dust created by power sanding, sawing, grinding, drilling, and other construction activities contains chemicals known to the State of California to cause cancer, birth defects or other reproductive harm. Some examples of these chemicals are:

- lead from lead-based paints,
- crystalline silica from bricks and cement and other masonry products, and
- arsenic and chromium from chemically-treated lumber.

Your risk from these exposures varies, depending on how often you do this type of work. To reduce your exposure to these chemicals: work in a well ventilated area, and work with approved safety equipment, such as those dust masks that are specially designed to filter out microscopic particles.

## MAKITA LIMITED ONE YEAR WARRANTY

### Warranty Policy

Every Makita tool is thoroughly inspected and tested before leaving the factory. It is warranted to be free of defects from workmanship and materials for the period of ONE YEAR from the date of original purchase. Should any trouble develop during this one year period, return the COMPLETE tool, freight prepaid, to one of Makita's Factory or Authorized Service Centers. If inspection shows the trouble is caused by defective workmanship or material, Makita will repair (or at our option, replace) without charge.

This Warranty does not apply where:

- repairs have been made or attempted by others:
- repairs are required because of normal wear and tear:
- the tool has been abused, misused or improperly maintained:
- alterations have been made to the tool.

IN NO EVENT SHALL MAKITA BE LIABLE FOR ANY INDIRECT, INCIDENTAL OR CONSEQUENTIAL DAMAGES FROM THE SALE OR USE OF THE PRODUCT. THIS DISCLAIMER APPLIES BOTH DURING AND AFTER THE TERM OF THIS WARRANTY.

MAKITA DISCLAIMS LIABILITY FOR ANY IMPLIED WARRANTIES, INCLUDING IMPLIED WARRANTIES OF "MERCHANTABILITY" AND "FITNESS FOR A SPECIFIC PURPOSE," AFTER THE ONE YEAR TERM OF THIS WARRANTY.

This Warranty gives you specific legal rights, and you may also have other rights which vary from state to state. Some states do not allow the exclusion or limitation of incidental or consequential damages, so the above limitation or exclusion may not apply to you. Some states do not allow limitation on how long an implied warranty lasts, so the above limitation may not apply to you.

**Makita Corporation**  
3-11-8, Sumiyoshi-cho,  
Anjo, Aichi 446-8502 Japan