



European  
Commission

Non-binding guide  
to good practice  
for implementing  
Directive 2013/35/EU

# Electromagnetic Fields

Volume 2: Case Studies

This publication has received financial support from the European Union Programme for Employment and Social Innovation "EaSI" (2014-2020).

For further information please consult: <http://ec.europa.eu/social/easi>

Non-binding guide  
to good practice  
for implementing  
Directive 2013/35/EU

# Electromagnetic Fields

Volume 2  
Case Studies

**European Commission**  
Directorate-General  
for Employment, Social Affairs and Inclusion  
Unit B3

Manuscript completed in November 2014

Neither the European Commission nor any person acting on behalf of the Commission may be held responsible for the use that may be made of the information contained in this publication.

The links in this publication were correct at the time the manuscript was completed.

Cover photo: © corbis

For any use or reproduction of photos which are not under European Union copyright, permission must be sought directly from the copyright holder(s).

Europe Direct is a service to help you find answers  
to your questions about the European Union.

Freephone number (\*):

00 800 6 7 8 9 10 11

(\* The information given is free, as are most calls (though some operators, phone boxes or hotels may charge you).

More information on the European Union is available on the Internet (<http://europa.eu>).

Luxembourg: Publications Office of the European Union, 2015

Print ISBN 978-92-79-45917-7 doi 10.2767/098908 KE-04-15-141-EN-C

PDF ISBN 978-92-79-45937-5 doi 210.2767/97726 KE-04-15-141-EN-N

© European Union, 2015

Reproduction is authorised provided the source is acknowledged.

# CONTENTS

Case Studies .....	7
<b>1. Office .....</b>	<b>9</b>
1.1 Workplace .....	9
1.2 Nature of the work .....	9
1.3 Approach to assessment .....	10
1.4 Results from the assessment .....	10
1.5 Risk assessment .....	10
1.6 Precautions already in place .....	11
1.7 Additional precautions as a result of the assessment .....	11
<b>2. Nuclear Magnetic Resonance (NMR) Spectrometer .....</b>	<b>12</b>
2.1 Workplace .....	12
2.2 Nature of the work .....	12
2.3 Information on the equipment giving rise to EMF .....	12
2.4 Approach to assessment of exposure .....	13
2.5 Results from exposure assessment .....	14
2.6 Risk assessment .....	14
2.7 Precautions already in place .....	15
2.8 Additional precautions as a result of the assessment .....	16
<b>3. Electrolysis .....</b>	<b>17</b>
3.1 Workplace .....	17
3.2 Nature of the work .....	17
3.3 Information on the equipment giving rise to EMF .....	17
3.3.1 Electrolyser cell room .....	17
3.3.2 Rectifier cubicle bay .....	18
3.4 How the application is used .....	20
3.5 Approach to assessment of exposure .....	20
3.5.1 Electrolyser cell room .....	21
3.5.2 Rectifier cubicle bay .....	21
3.6 Results from exposure assessment .....	22
3.6.1 Electrolyser cell room .....	23
3.6.2 Rectifier bay .....	27
3.7 Risk assessment .....	29
3.8 Precautions already in place .....	31
3.9 Additional precautions as a result of the assessment .....	31
3.10 Further information .....	31
<b>4. Medical .....</b>	<b>32</b>
4.1 Workplace .....	32
4.2 Nature of the work .....	32
4.3 Information on the equipment giving rise to EMF .....	32
4.3.1 Electrosurgery units .....	32
4.3.2 Transcranial magnetic stimulation .....	33
4.3.3 Short wave diathermy .....	34

4.4	How the applications are used.....	34
4.4.1	Electrosurgery units.....	34
4.4.2	Transcranial magnetic stimulation.....	34
4.4.3	Short wave diathermy.....	35
4.5	Approach to assessment of exposure.....	35
4.6	Results from exposure assessment.....	36
4.6.1	Electrosurgery unit.....	36
4.6.2	TMS device.....	39
4.6.3	Short wave diathermy.....	43
4.7	Risk assessment.....	43
4.7.1	Electrosurgery unit.....	43
4.7.2	TMS device.....	43
4.8	Precautions already in place.....	46
4.9	Additional precautions as a result of the assessment.....	46
4.9.1	Electrosurgery unit.....	46
4.9.2	TMS device.....	46
4.9.3	Short wave diathermy.....	47
<b>5.</b>	<b>Engineering Workshop.....</b>	<b>48</b>
5.1	Workplace.....	48
5.2	Nature of the work.....	48
5.3	How the applications are used.....	48
5.3.1	Magnetic particle inspection.....	48
5.3.2	Demagnetiser.....	49
5.3.3	Surface grinding machine.....	50
5.3.4	Other tools used in the workshop.....	50
5.4	Information on the equipment giving rise to EMF.....	51
5.5	Approach to assessment of exposure.....	51
5.6	Results from exposure assessment.....	51
5.6.1	Magnetic particle inspection.....	51
5.6.2	Demagnetiser.....	52
5.6.3	Surface grinding machine.....	54
5.6.4	Other tools used in the workshop.....	54
5.7	Risk assessment.....	55
5.8	Precautions already in place.....	59
5.9	Additional precautions as a result of the assessment.....	59
5.10	Further information.....	61
<b>6.</b>	<b>Automotive.....</b>	<b>63</b>
6.1	Workplace.....	63
6.2	Nature of the work.....	63
6.3	How the applications are used.....	63
6.4	Information on the equipment giving rise to EMF.....	65
6.5	Approach to assessment of exposure.....	67
6.6	Results from exposure assessments.....	68
6.6.1	Results from exposure assessment of repair shop spot welders.....	69
6.6.2	Results from exposure assessment of induction heaters used in the body repair shop.....	71
6.7	Conclusions of exposure assessments.....	72
6.8	Risk assessment.....	74
6.9	Precautions already in place.....	74
6.10	Additional precautions as a result of the assessments.....	75
6.11	Spot welders in vehicle manufacture.....	76
6.11.1	Factory spot welder assessment.....	76
6.11.2	Factory spot welder measurement results.....	78

6.11.3	Factory spot welder measurement results in the context of the ALs.....	80
6.11.4	Factory spot welder measurement results in the context of the ELVs.....	80
<b>7.</b>	<b>Welding.....</b>	<b>83</b>
7.1	Workplace.....	83
7.2	Nature of the work.....	83
7.3	Information on the equipment giving rise to EMF.....	83
7.3.1	Spot welders.....	83
7.3.2	Seam welder.....	84
7.4	How the applications are used.....	85
7.5	Approach to assessment of exposure.....	85
7.6	Results from exposure assessment.....	86
7.6.1	Bench-top spot welder.....	86
7.6.2	Portable suspended spot welder.....	87
7.6.3	Seam welder.....	89
7.7	Risk assessment.....	90
7.8	Precautions already in place.....	94
7.9	Additional precautions as a result of the assessment.....	94
7.10	Further information.....	95
7.10.1	Bench-top spot welder.....	95
7.10.2	Portable suspended spot welder.....	96
7.10.3	Seam welder.....	96
<b>8.</b>	<b>Metallurgical Manufacturing.....</b>	<b>98</b>
8.1	Workplace.....	98
8.2	Nature of the work.....	98
8.3	Information on the equipment giving rise to EMF and how it is used.....	98
8.3.1	Small volume alloy production facility.....	98
8.3.2	Ferro-titanium production facility.....	99
8.3.3	Large electrical melting facility.....	99
8.3.4	Arc furnace facility.....	100
8.3.5	Analytical services laboratory.....	100
8.4	Approach to assessment of exposure.....	101
8.4.1	Small volume alloy production facility.....	101
8.4.2	Ferro-titanium production facility.....	101
8.4.3	Large electric melting facility.....	101
8.4.4	Arc furnace facility.....	102
8.4.5	Analytical services laboratory.....	102
8.5	Results from exposure assessment.....	102
8.5.1	Initial exposure assessment.....	102
8.5.2	Detailed exposure assessment of induction furnace in small volume alloy production facility.....	104
8.6	Risk assessment.....	106
8.7	Precautions already in place.....	108
8.8	Additional precautions as a result of the assessment.....	108
8.9	Further information.....	109
<b>9.</b>	<b>Radiofrequency (RF) Plasma Devices.....</b>	<b>112</b>
9.1	Nature of the work.....	112
9.2	Information on the equipment giving rise to EMF.....	112
9.3	How the application is used.....	113
9.4	Approach to assessment of exposure.....	113
9.5	Results from exposure assessment.....	115
9.6	Risk assessment.....	116
9.7	Precautions already in place.....	117

9.8	Additional precautions as a result of the assessment.....	118
9.9	Further information.....	119
<b>10.</b>	<b>Rooftop Antennas.....</b>	<b>120</b>
10.1	Workplace.....	120
10.2	Nature of the work.....	120
10.3	Information on the equipment giving rise to EMF.....	121
10.4	How the application is used.....	123
10.5	Approach to assessment of exposure.....	123
10.6	Results from exposure assessment.....	124
10.7	Risk assessment.....	125
10.8	Precautions already in place.....	126
10.9	Additional precautions as a result of the assessment.....	127
<b>11.</b>	<b>Walkie-talkies.....</b>	<b>128</b>
11.1	Workplace.....	128
11.2	Nature of the work.....	128
11.3	How the application is used.....	130
11.4	Approach to assessment of exposure.....	130
11.5	Results from exposure assessment.....	130
11.6	Risk assessment.....	130
11.7	Precautions already in place.....	131
11.8	Additional precautions as a result of the assessment.....	131
<b>12.</b>	<b>Airports.....</b>	<b>132</b>
12.1	Workplace.....	132
12.2	Nature of the work.....	132
12.2.1	Radar.....	132
12.2.2	Non-directional beacon.....	132
12.2.3	Distance measuring equipment.....	133
12.3	Information on the equipment giving rise to EMF.....	133
12.3.1	Radar.....	133
12.3.2	Non-directional beacon.....	134
12.3.3	Distance measuring equipment.....	134
12.4	How the applications are used.....	134
12.5	Approach to assessment of exposure.....	134
12.5.1	Radar.....	134
12.5.2	Non-directional beacon.....	136
12.5.3	Distance measuring equipment.....	136
12.6	Results from exposure assessment.....	136
12.6.1	Radar.....	137
12.6.2	Non-directional beacon.....	137
12.6.3	Distance measuring equipment.....	138
12.7	Risk assessment.....	138
12.8	Precautions already in place.....	141
12.8.1	Radar.....	141
12.8.2	Non-directional beacon.....	142
12.8.3	Distance measuring equipment.....	142
12.9	Additional precautions as a result of the assessment.....	142
12.9.1	Radar.....	142
12.9.2	Non-directional beacon.....	143
12.9.3	Distance measuring equipment.....	143



## CASE STUDIES

This assembly of case studies constitutes Volume 2 of the non-binding guide to good practice for implementing the EMF Directive (2013/35/EU). It must be read in conjunction with the main body of the guide which is contained in Volume 1.

The following case studies have been developed for a range of different occupational sectors that mainly involve workers from small to medium size enterprises. They are based on real assessments in real life situations. However, because of the complexity of some of these assessments they have been simplified or summarised in order to make them more useful to the reader and to limit the overall length of this volume. They are intended to illustrate a variety of practical approaches that may be taken by employers to manage the risks associated with exposure to electromagnetic fields. They include examples of good practice.

Some of the case studies contain contour plots that are intended to provide a schematic illustration (in plan view) of the measured (or calculated) exposure levels around featured items of equipment.

Some of the case studies include the results of computer modelling represented by colour distribution plots of the maximum induced electric field or specific energy absorption rate in the 2 mm<sup>3</sup> voxels making up the human model. The purpose of these plots is to provide a schematic illustration of where the field is absorbed in the human body, rather than precise information about the magnitude of these fields. In the low frequency plots the maximum induced electric fields, and not the 99th percentile induced electric fields (used for comparison with the ELVs), are displayed.

The case studies included in this volume are as follows:

- 1 **Office**
- 2 **Nuclear Magnetic Resonance (NMR) Spectrometer**
- 3 **Electrolysis**
- 4 **Medical**
- 5 **Engineering Workshop**
- 6 **Automotive**
- 7 **Welding**
- 8 **Metallurgical Manufacturing**
- 9 **Radiofrequency (RF) Plasma Devices**
- 10 **Rooftop Antennas**
- 11 **Walkie-talkies**
- 12 **Airports**



# 1. OFFICE

## 1.1 Workplace

This case study relates to a group of offices within a medium size engineering company. The offices contain usual electrical office equipment powered by mains electricity. The computers are a combination of: desktops, connected to a Local Area Network (LAN); laptops which use a WiFi system and a network server. There is also a small kitchen for workers to use. Electrical equipment within the kitchen includes a kettle, refrigerator and microwave oven. There is also a larger central network server which is housed in a separate room. The office area is kept secure using a radio frequency identification (RFID) access control system, with each office worker having an access token. The office manager decided to review the office risk assessment after hearing from colleagues about new legislation implementing the EMF Directive.

## 1.2 Nature of the work

Office workers spend much of their time working on computers and making telephone calls on cordless (DECT) and mobile phones. Access tokens on lanyards allow access to the offices when placed close to RFID door locks. Some of these sources of electromagnetic fields are shown in Figure 1.1. All workers could make use of the kitchen to make hot drinks and reheat meals with the microwave oven.

**Figure 1.1 — Sources of electromagnetic fields in the office**



### 1.3 Approach to assessment

The office manager walked around the office area making a note of equipment that uses electricity, including those that generate electromagnetic fields, and spoke to workers to ensure that no items had been missed. After reading the first section of the non-binding guide to good practice for implementing Directive 2013/35/EU 'Electromagnetic Fields', the manager realised that the best approach to assessing the risk was to see if the identified items appeared within Table 3.2 in Chapter 3 of Volume 1 of the guide. If any items were not listed within this table further assessment might be required.

### 1.4 Results from the assessment

The office manager listed all the electrical equipment (Table 1.1) and noted if it appeared within Table 3.2 in Chapter 3 of Volume 1 of the guide.

**Table 1.1 — List of electrical equipment within the office area**

Item	Low risk to any worker (Table 3.2, Chapter 3)	Assessment needed for workers wearing AIMD or body worn medical devices (Table 3.2, Chapter 3)	Comments
Computers	✓		
Network Server with associated UPS and network wiring	✓		Output of UPS will be similar to that of normal electrical supply
Laptops (Wi-Fi enabled)		✓	
Cordless (DECT) phones		✓	
Mains electrical wiring	✓		
Mobile phones		✓	
Photocopier	✓		
Wi-Fi access hubs		✓	
Kettle	✓		
Refrigerator	✓		
Microwave oven	✓		Oven needs to be well maintained
RFID security access		✓	

### 1.5 Risk assessment

The results of the assessment indicate that use of office equipment detailed in Table 3.2 of Chapter 3 of Volume 1 of the guide will not exceed the relevant health effects ELVs within the EMF Directive. However there is a possibility that others in Table 3.2 may cause interference with active implanted medical devices (AIMDs) or body worn medical devices fitted to workers. The EMF specific risk assessment shown in Table 1.2 was added to the general office risk assessment.

## 1.6 Precautions already in place

Periodic checks on the overall condition of the microwave oven are done during routine office safety surveys.

## 1.7 Additional precautions as a result of the assessment

The office manager puts in place a few simple measures:

- any new equipment of a different type needs to be reviewed with the EMF Directive in mind to see whether it changes the outcome of the risk assessment;
- when any office worker reports that they are at particular risk due to an active implanted medical device, the office manager will review with them the information that has been provided to them by a medical professional responsible for their care.

**Table 1.2 — EMF specific additions to general office risk assessment**

Hazards	Existing preventive and precautionary measures	People at risk	Severity			Likelihood			Risk evaluation	New preventive and precautionary actions
			Minor	Serious	Fatal	Improbable	Possible	Probable		
EMF radiation from microwave oven	Periodic checks on the overall condition of the oven including damage to door seals, window grille and operation of interlocks	All workers	✓			✓			Low	None required
Interference with active implanted medical devices (AIMDs) or body worn medical devices from EMF radiation	None	Workers at particular risk	✓			✓			Low	Ensure that workers with medical electrical equipment or devices are subject to an individual risk assessment on return to work where any precautions recommended by their medical consultant can be identified and implemented  Any new equipment will need assessing

## 2. NUCLEAR MAGNETIC RESONANCE (NMR) SPECTROMETER

### 2.1 Workplace

Nuclear magnetic resonance (NMR) spectrometers can present a hazard due to strong static magnetic fields. They are used to investigate the properties of materials, for example in manufacturing industries for the analysis of chemical compounds. This case study is set in a pharmaceutical company where the NMR units are located within a dedicated spectroscopy laboratory. There were plans to purchase a new unit and the Safety Officer wanted to review the risk assessment before developing an action plan.

### 2.2 Nature of the work

Small samples of the material to be analysed are loaded, either singly by hand, or in batches automatically via a carousel, into the vertical bore of the NMR unit (Figure 2.1).

**Figure 2.1 — NMR unit, complete with sample carousel and loading platform**



### 2.3 Information on the equipment giving rise to EMF

In preparation for the review the Safety Officer gathered general information on NMR units and noted that:

- The electromagnet generates a strong static (0 Hz) magnetic field; flux densities range from approximately 0.5 to 20 T depending on the unit. Small bench-top units tend to use rare earth permanent magnets, whereas larger stand-alone units use

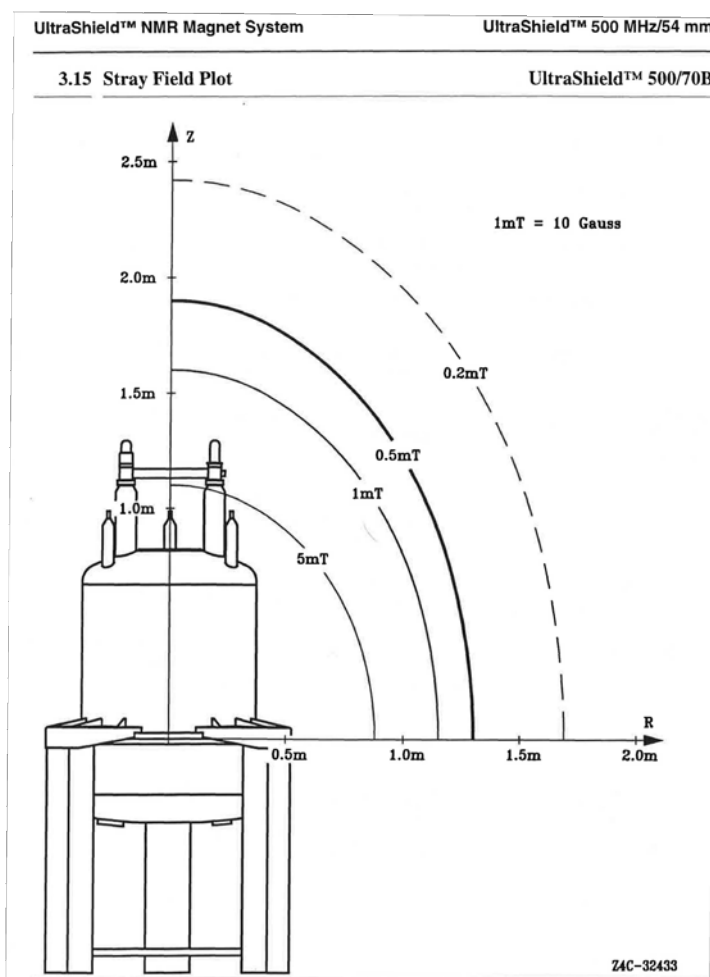
superconducting magnets. The magnet remains fully energised for long periods of time to improve the stability of the field and it is not practicable to reduce the field strength when workers approach.

- Manufacturers have progressively improved the design of their units to incorporate passive and active shielding to reduce the strength of the static magnetic field accessible to the worker. Thus it may be possible to contain the hazardous magnetic field almost entirely within the confines of the cryostat. In older, or less well shielded units, the hazardous magnetic field may extend a few metres into the work area.
- These external magnetic fields tend to be distorted and channelled by steel structures (e.g. girders) within the building.

## 2.4 Approach to assessment of exposure

The Safety Officer was aware that the manufacturer of the new unit was able to provide information on the strength of the static magnetic field accessible to workers. More importantly the manufacturer was able to describe the extent of any hazard from indirect effects, such as the projectile risk from ferromagnetic objects or interference with medical electronic equipment and devices. In keeping with good practice, the manufacturer was able to provide a plot of the stray static magnetic field around the unit (Figure 2.2).

**Figure 2.2 — Plot of the stray static magnetic field around the NMR unit**



The Safety Officer was aware that it would also be possible to assess the static magnetic field strength around the unit with an appropriate magnetometer; and that it would be much easier to obtain a reliable result with an isotropic (three-axis) probe than with a single axis probe. However, this approach would require an investment of time and money and also consideration the hazards associated with making the measurements, especially if the instrument was metal clad. In the evaluation, the Safety Officer ruled out making measurements on the basis that the manufacturer would provide good information.

The Safety Officer also considered which groups of workers would have access to the NMR Laboratory and the tasks they were likely to undertake. He identified that service engineers from the manufacturers of the NMR units would be allowed occasional access and they would access high field strength areas, for example the base of the cryostat for spectrometer tuning operations. However, he noted that his company would require these engineers to provide a written risk assessment and safety procedures for their work and they would be expected to demonstrate their competence (e.g. through evidence of appropriate training and practical experience) in advance of their visit. On this basis, he evaluated the risks associated with their work to be low. He also noted that cleaning contractors would not be allowed access to the laboratory.

## 2.5 Results from exposure assessment

From the review of the existing units within the NMR Laboratory, the Safety Officer was aware that there may be considerable variation in the hazard distance depending on the design and particularly the shielding: for older high field strength unshielded units this may be several metres, whereas for modern well shielded units it may be practically zero. However, the field strength was not expected to exceed the exposure limit values (ELVs) for direct effects at locations accessible to company workers. Although there was significant power output from the radiofrequency amplifier, the radiofrequency field was expected to be fully contained within the unit and not accessible to workers.

From the information provided by the manufacturer (Figure 2.2), the Safety Officer identified that the action levels (ALs) for indirect effects were likely to be exceeded within 1.3 m of the outside surface of the cryostat.

## 2.6 Risk assessment

The Safety Officer was aware that there was already a risk assessment for the NMR Laboratory on file and noted that this followed the methodology suggested by OiRA (the EU-OSHA's online interactive risk assessment platform). This evaluates all risks to workers in the laboratory, including those from:

- work at height when loading the samples;
- cryogenic liquids and 'quenching' of the superconducting magnets;
- asphyxiant atmosphere of nitrogen in enclosed spaces beneath the cryostat, such as sample changing sumps;
- projectile ferromagnetic objects (e.g. tools and instruments);
- interference with medical electronic equipment and devices.

Accordingly, it would be a straightforward matter to record the new action plan from the current review in the existing risk assessment. An example of an EMF specific risk assessment for the NMR Laboratory is shown in Table 2.1.



## 2.7 Precautions already in place

The Safety Officer identified that a range of organisational measures have been adopted within the NMR Laboratory to prevent or restrict exposure. First amongst these has been to choose NMR units with 'state of the art' passive or active shielding. Other good practice measures included:

- locating the NMR units in a dedicated laboratory with physical access control, in the form of key pad access;
- posting warning and prohibition notices complying with Directive 92/58/EEC on the entrance door into the laboratory (Figure 2.3). This includes a warning for people wearing medical electronic equipment;
- preventing the entry of ferromagnetic tools and other objects into the laboratory;
- segregating the NMR units from other laboratory equipment and workstations;
- erecting a chain-link barrier and marking the floor, at the position of the 0.5 mT contour in order to control access (Figure 2.4);
- providing information, instruction and training to those working in the laboratory and ensuring that there is adequate supervision;
- requiring service engineers to provide written safety documentation and demonstrate their competence in advance of their visit.

**Figure 2.3 — Warning and prohibition notices on the entrance door into the NMR Laboratory**



**Figure 2.4 — Demarcation of the restricted area by a chain-link barrier and marking the floor**



**Table 2.1 — EMF specific risk assessment for NMR Laboratory**

Hazards	Existing preventive and precautionary measures	People at risk	Severity			Likelihood			Risk evaluation	New preventive and precautionary actions
			Minor	Serious	Fatal	Improbable	Possible	Probable		
Static magnetic field direct effects	Dedicated laboratory with physical access control	Laboratory workers	✓			✓			Low	
	Warning and prohibition notices									
	Information, instruction and training									Refresher training Include article in safety bulletin
	Require written safety documentation and demonstration of competence	Service engineers	✓			✓			Low	
	Cleaners not allowed access	Cleaners	✓			✓			Low	Ensure cleaners are aware
Static magnetic field indirect effects (interference with medical implants, projectile risk)	Preventing the entry of ferromagnetic objects	All of the above		✓			✓		Low	Ensure maintenance workers are aware
	See above	Workers at particular risk		✓			✓		Low	See above
Radiofrequency field	Fully contained within the unit and not accessible	All of the above	✓				✓		Low	None

## 2.8 Additional precautions as a result of the assessment

The Safety Officer was generally content with the review of the risk assessment and evaluation of the hazards associated with the new unit. The organisational measures were considered to be sufficient although it was five years since workers last received training in the hazards and precautions associated with the NMR Laboratory. Accordingly the Safety Officer developed an action plan with the following elements:

- refresh the training of workers in the laboratory with a series of short awareness sessions, the priority being given to new recruits;
- ensure that maintenance workers are aware of the hazards, particularly from ‘flying ferromagnetic tools’;
- confirm that cleaning contractors are aware that they are prohibited from entering the laboratory;
- include an article on the hazards associated with the laboratory in the next company safety bulletin.

## 3. ELECTROLYSIS

The sources of EMF in this case study include the following:

- electrolysers
- thyristor rectifiers
- busbars
- transformers.

### 3.1 Workplace

The equipment was installed in a large chlorine production facility. The workplaces of interest were as follows:

- the electrolyser cell room
- the rectifier cubicle bays.

### 3.2 Nature of the work

The majority of work on the equipment was carried out by qualified and experienced engineering workers, who may be required to work on any of the equipment associated with the chlorine production facility. This could involve periodically stripping down and servicing an electrolyser while adjacent electrolysers were live.

The facility was relatively new, and EMF safety had been taken into consideration at the design stage. This case study is therefore an example of good practice, and emphasises the importance of considering EMF exposure in the planning stages of a major project.

### 3.3 Information on the equipment giving rise to EMF

#### 3.3.1 Electrolyser cell room

The electrolyser cell room contained 20 electrolysers, which produce chlorine by applying an electrical current to brine by the method of membrane cell electrolysis. A 450 V, 16.5 kA direct current was applied to each electrolyser. Perspex guarding had been installed around the electrolysers to prevent access to live electrical conductors.

Including the guarding, each electrolyser was 17.2 m in length and 4.4 m in width, and consisted of 138 cells split into two 'packs' of 69 cells each, which were connected in series. The electrolysers were separated by a distance of approximately 1.1 m. The arrangement of the electrolysers is shown in Figure 3.1.

A theoretical modelling assessment based on calculations of magnetic fields around the current conducting parts of the facility had been carried out at the design stage to provide confidence that exposures to EMF would be minimised.

**Figure 3.1 — Electrolysers in the cell room**

**A single electrolyser,  
viewed along its  
length**



**Several  
electrolysers**



### 3.3.2 Rectifier cubicle bay

Each rectifier cubicle bay (Figure 3.2) contained a thyristor rectifier, which provided a DC supply to two electrolysers. Busbars supplying the electrolysers passed overhead at a height of approximately 4.2 m above floor level. The bays were fenced off to prevent access from outside the building and the door to each bay was locked with a warning notice displayed alongside (Figure 3.3). Access to the bays is not normally allowed when the electrolysers are operating.

The transformers supplying the cell room were located outside the rectifier cubicle bays, on the other side of the wall from the rectifiers. The transformer bays were also fenced off to prevent access (Figure 3.4).

Figure 3.2 — A rectifier cubicle bay

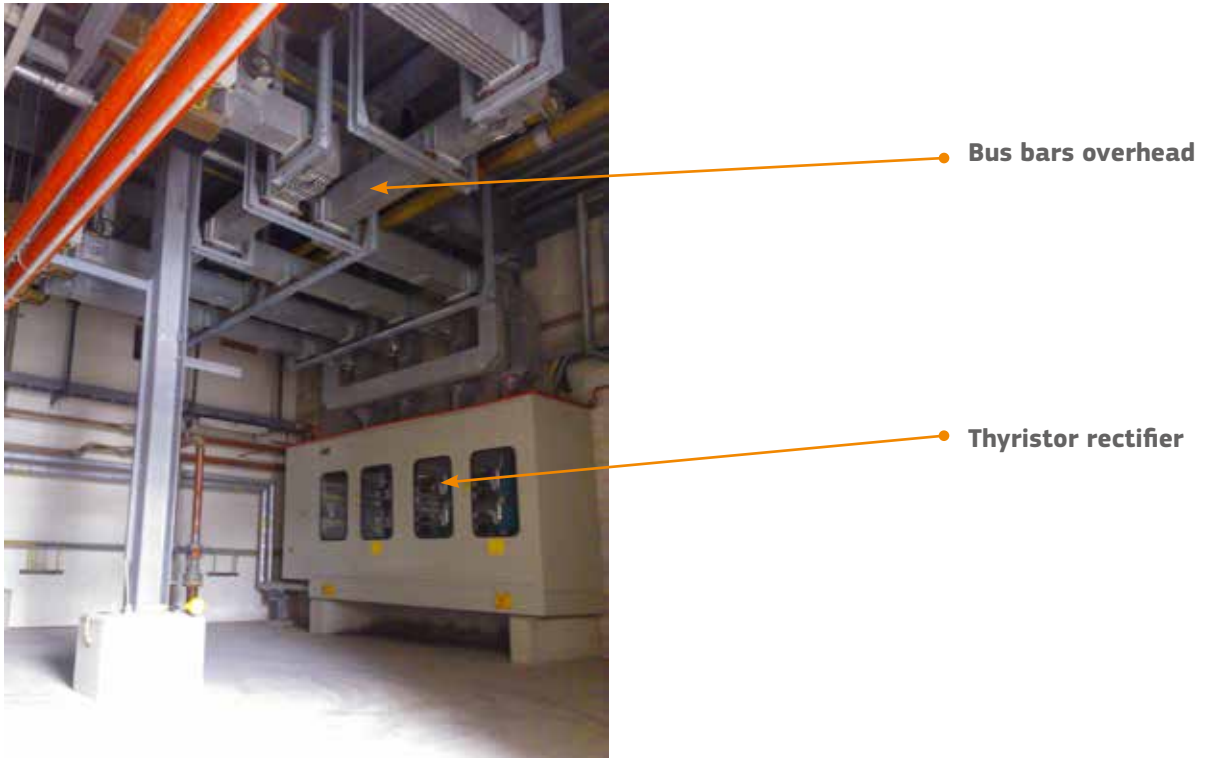
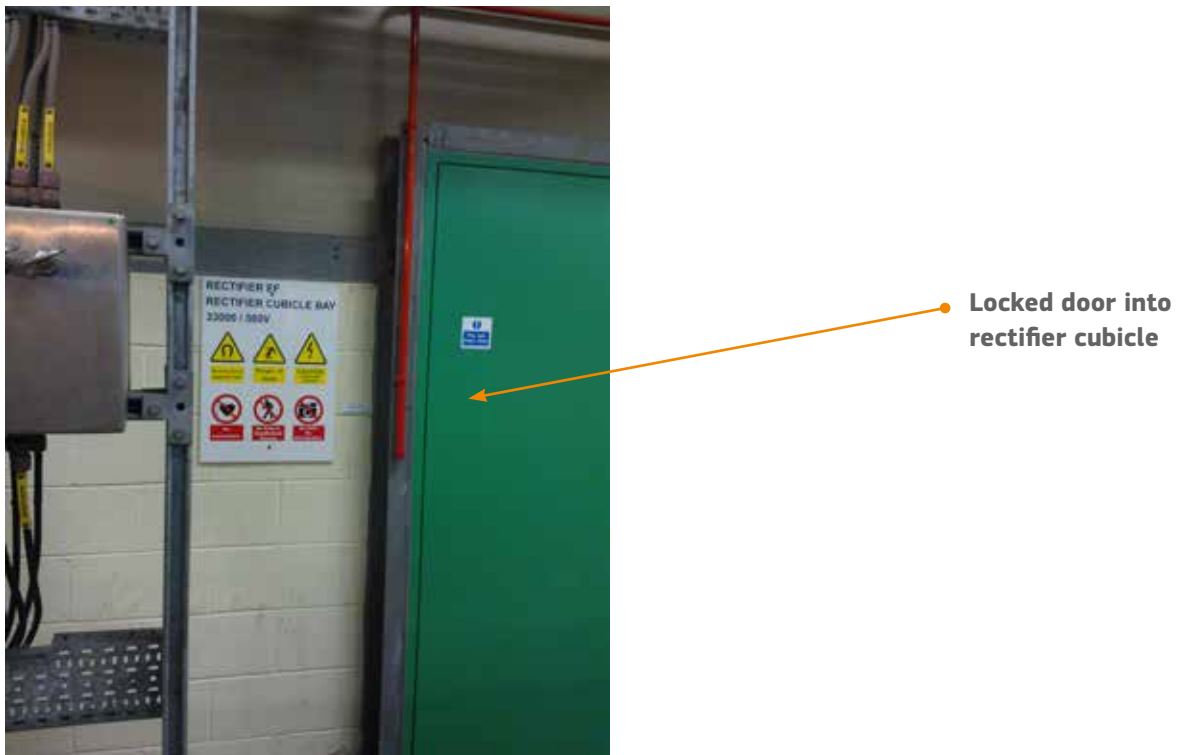


Figure 3.3 — Restriction of access to a rectifier cubicle bay



**Figure 3.4 — The transformer bays**



### 3.4 How the application is used

The chlorine production process is automated and managed remotely from a control room in a nearby building.

### 3.5 Approach to assessment of exposure

Measurements of exposures were made by an expert consultant using specialised instrumentation. As the facility had been designed with EMF safety in mind, and the design included a theoretical modelling assessment based on calculations of magnetic fields around the current conducting parts of the facility, the purpose of the measurements was to confirm that the protection and prevention measures already in place were effective in restricting exposure to EMF.

Measurements were made of both static magnetic flux density, due to the direct current supplied to the electrolyzers, and time varying magnetic flux density, due to the fact that the direct current was produced from the rectification of an alternating current supply, and so some ripple was expected on the direct current supplied to the electrolyzers. The frequency of the ripple was also confirmed during the exposure assessment.

The consultant carried out a 'time and motion' study prior to making the measurements to ensure that these were made in locations representative of normal working positions. The measurements were made while the electrolyzers were operating at constant load.

The measurement results were compared with the appropriate exposure limit values (ELVs) and action levels (ALs) for direct effects, as well as the ALs for indirect effects for static magnetic fields (interference with active implanted medical devices, and attraction and projectile risk in the fringe field of high field strength sources).

When assessing the exposure of workers at particular risk, comparison was made with the reference levels given in the Council Recommendation (1999/519/EC) (see Appendix E of Volume 1 of the guide).

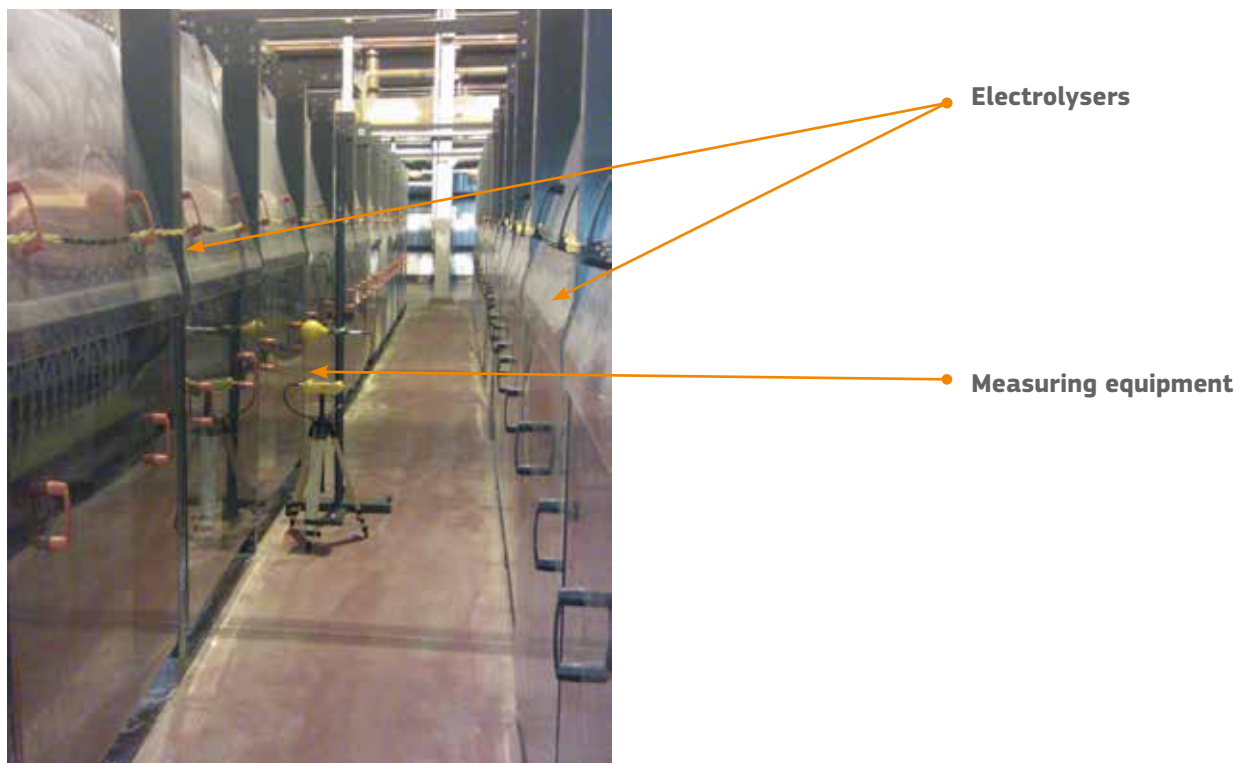
### 3.5.1 Electrolyser cell room

Measurements of time varying magnetic flux density and static magnetic flux density were made between two electrolyzers (Figure 3.5). Three sets of measurements were made:

- at distance intervals across the gap between the two electrolyzers;
- at distance intervals along the full length of the centre of the gap from one end of the electrolyzers to the other;
- in the vertical plane alongside one of the electrolyzers.

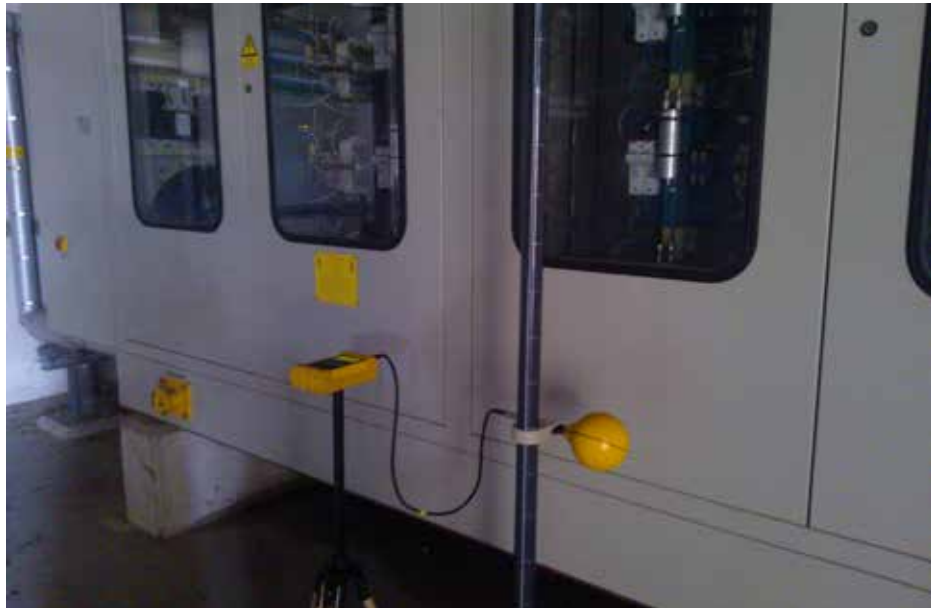
These measurements gave a representation of the exposure of a worker walking between the electrolyzers in the cell room, which is considered to be the worst case exposure scenario.

**Figure 3.5 — Measurements being made between two electrolyzers**



### 3.5.2 Rectifier cubicle bay

Measurements of time varying magnetic flux density and static magnetic flux density were made around a thyristor rectifier (Figure 3.6), underneath busbars, and close to the wall between the rectifier and transformer.

**Figure 3.6 — Measurements being made near a thyristor rectifier**

### 3.6 Results from exposure assessment

The results of the exposure measurements were compared with the appropriate ELVs and ALs. In the case of electrolysis, the important values with which to compare the measurement results are:

- for static magnetic fields:
  - ELV for magnetic flux density of static magnetic fields (normal working conditions);
  - action level for magnetic flux density of static magnetic fields (interference with active implanted medical devices such as cardiac pacemakers);
  - action level for magnetic flux density of static magnetic fields (attraction and projectile risk in the fringe field of high field strength sources).
- for time varying magnetic fields:
  - action levels for magnetic flux density of time varying magnetic fields,
  - the reference levels given in the Council Recommendation (1999/519/EC) for time varying magnetic fields (for workers at particular risk).

The significant findings of the exposure assessment, along with some examples of the diagrams produced in the theoretical modelling assessment, are presented in Figures 3.7 to 3.17.

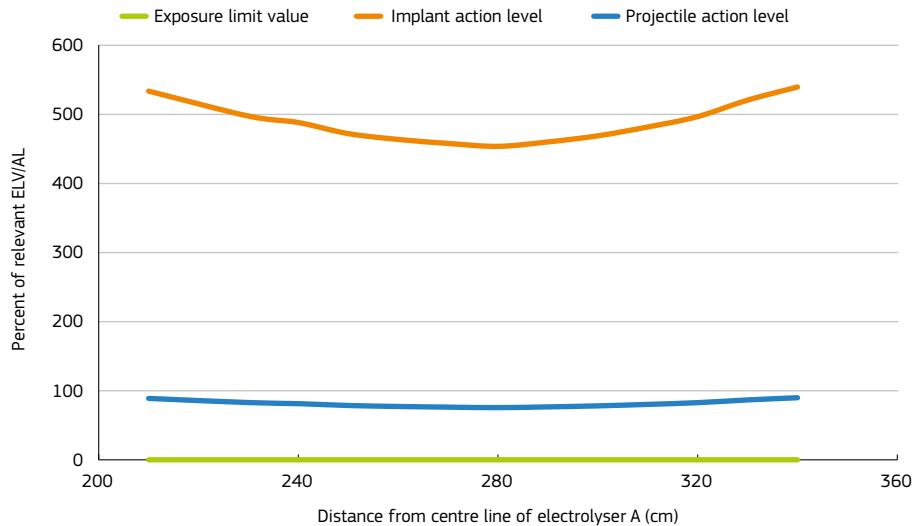
It should be noted that the results of the exposure assessment cannot be compared directly with the modelling assessment because the modelling assessment was carried out before the publication of the EMF Directive and was based on the ICNIRP occupational reference levels, which were more restrictive than the action levels in the EMF Directive.



### 3.6.1 Electrolyser cell room

The following graphs show the variation of magnetic flux density in relation to the applicable ELVs and ALs described above. The frequency of the ripple on the DC supply was confirmed to be 300 Hz. Harmonics at 600 Hz and 900 Hz were also detected by the measuring equipment, although the contribution of the harmonics to the total exposure was not significant in this case.

**Figure 3.7 — Variation of static magnetic flux density across the gap between the two electrolyzers**



*NB:* Measurements were made at a height of 120 cm above floor level.

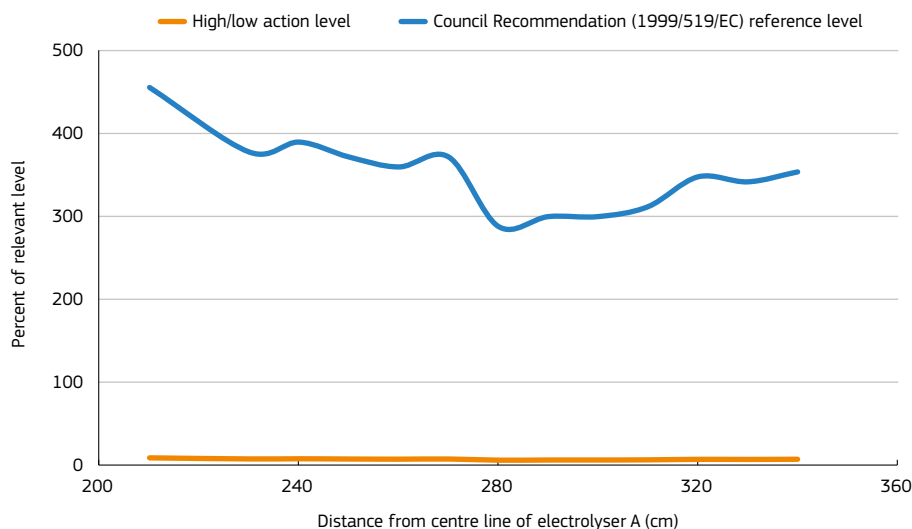
Exposure limit value (normal working conditions): 2 T

Implant action level: 0.5 mT

Projectile action level: 3 mT

The uncertainty in the measurements was estimated to be  $\pm 5\%$  and in accordance with the 'shared risk' approach (see Appendix D5 of Volume 1 of the Guide) the results were taken as direct percentages of the ELV/ALs.

**Figure 3.8 — Variation of 300 Hz time varying magnetic flux density across the gap between the two electrolyzers**



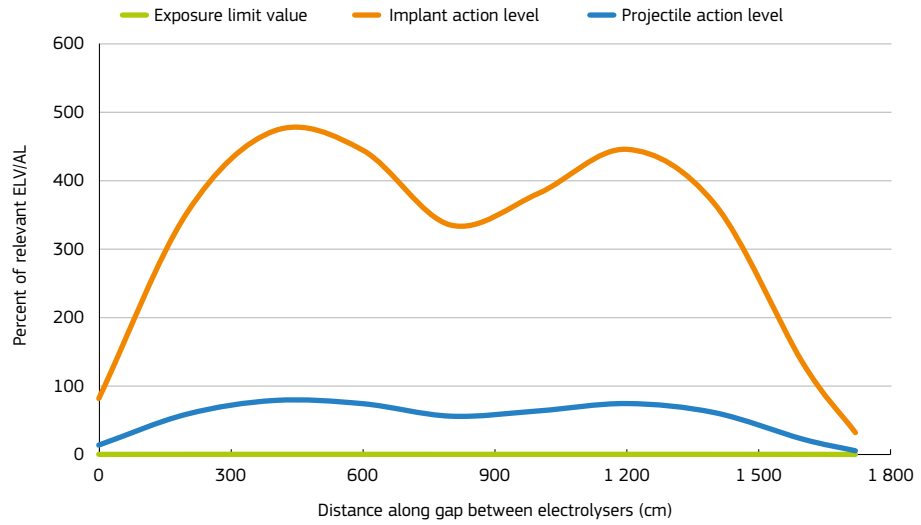
*NB:* Measurements were made at a height of 120 cm above floor level.

High and low action levels for 300 Hz magnetic field: 1000  $\mu$ T

Council Recommendation (1999/519/EC) reference level for 300 Hz magnetic field: 16.7  $\mu$ T

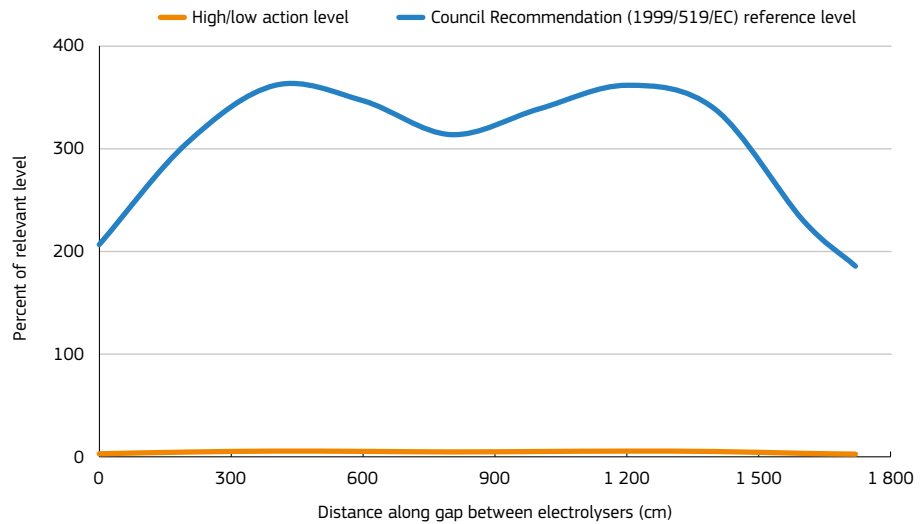
The uncertainty in the measurements was estimated to be  $\pm 10\%$  and in accordance with the 'shared risk' approach (see Appendix D5 of Volume 1 of the Guide) the results were taken as direct percentages of the AL/RL.

**Figure 3.9 — Variation of static magnetic flux density along the length of the gap between the two electrolyzers**



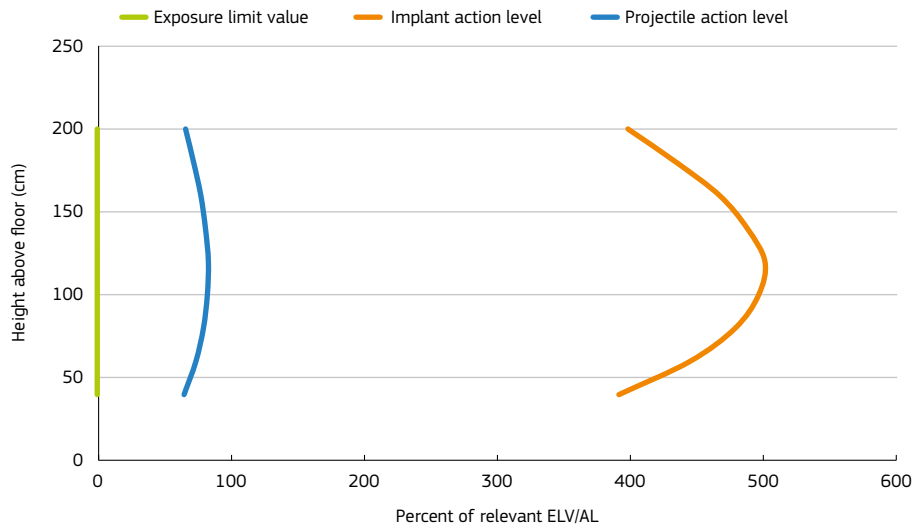
*NB:* Measurements were made at a height of 120 cm above floor level.  
 Implant action level: 0.5 mT  
 Projectile action level: 3 mT  
 The uncertainty in the measurements was estimated to be ±5 % and in accordance with the 'shared risk' approach (see Appendix D5 of Volume 1 of the Guide) the results were taken as direct percentages of the ELV/ALs.

**Figure 3.10 — Variation of 300 Hz time varying magnetic flux density along the length of the gap between the two electrolyzers**



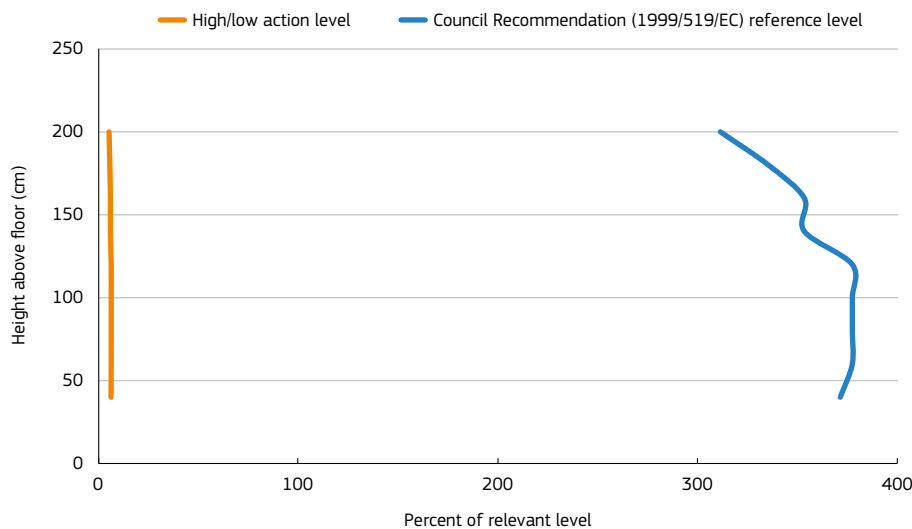
*NB:* Measurements were made at a height of 120 cm above floor level.  
 High and low action levels for 300 Hz magnetic field: 1000 µT  
 Council Recommendation (1999/519/EC) reference level for 300 Hz magnetic field: 16.7 µT  
 The uncertainty in the measurements was estimated to be ±10 % and in accordance with the 'shared risk' approach (see Appendix D5 of Volume 1 of the Guide) the results were taken as direct percentages of the AL/RL.

**Figure 3.11 — Variation of static magnetic flux density with height alongside one of the electrolyzers**



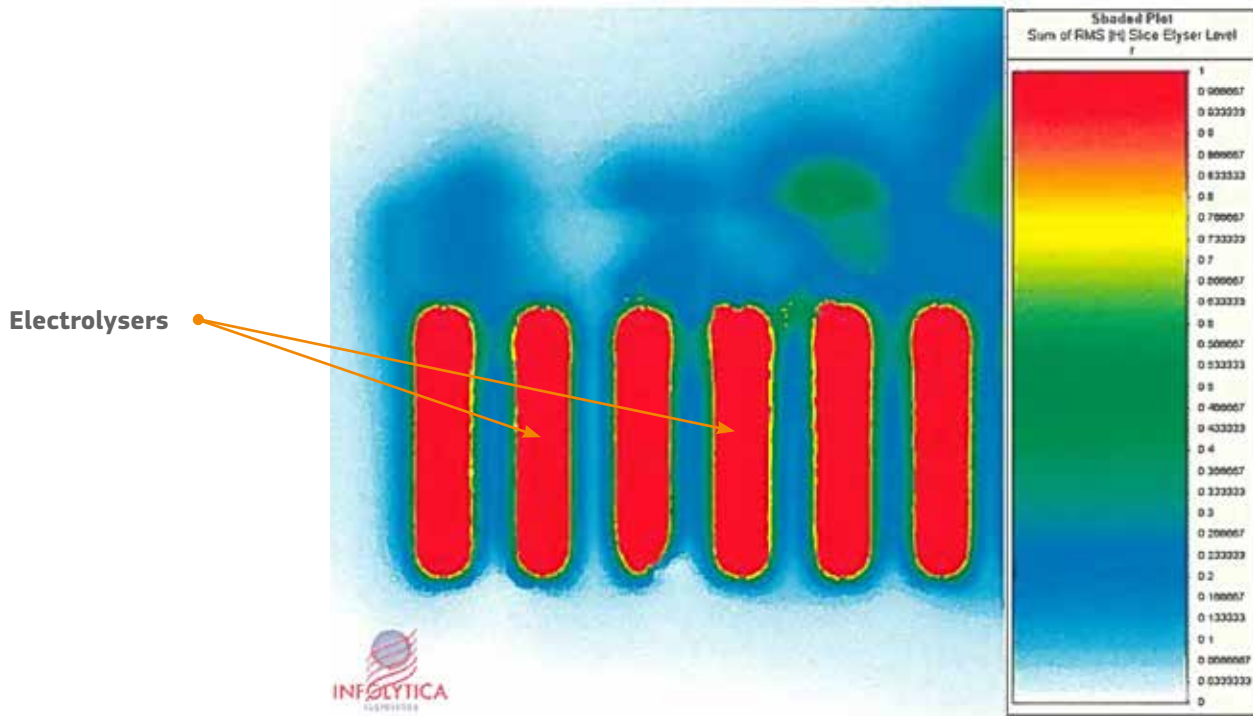
*NB:* Measurements were made at a distance of 230 cm from the centre line of one the electrolyzers.  
 Exposure limit value (normal working conditions): 2 T  
 Implant action level: 0.5 mT  
 Projectile action level: 3 mT  
 The uncertainty in the measurements was estimated to be  $\pm 5\%$  and in accordance with the 'shared risk' approach (see Appendix D5 of Volume 1 of the Guide) the results were taken as direct percentages of the ELV/ALS.

**Figure 3.12 — Variation of 300 Hz time varying magnetic flux density with height alongside one of the electrolyzers**



*NB:* Measurements were made at a distance of 230 cm from the centre line of one the electrolyzers.  
 High and low action levels for 300 Hz magnetic field: 1000  $\mu$ T  
 Council Recommendation (1999/519/EC) reference level for 300 Hz magnetic field: 16.7  $\mu$ T  
 The uncertainty in the measurements was estimated to be  $\pm 10\%$  and in accordance with the 'shared risk' approach (see Appendix D5 of Volume 1 of the Guide) the results were taken as direct percentages of the AL/RL.

**Figure 3.13 — Example of a theoretical modelling assessment diagram for the electrolyser cell room (plan view)**



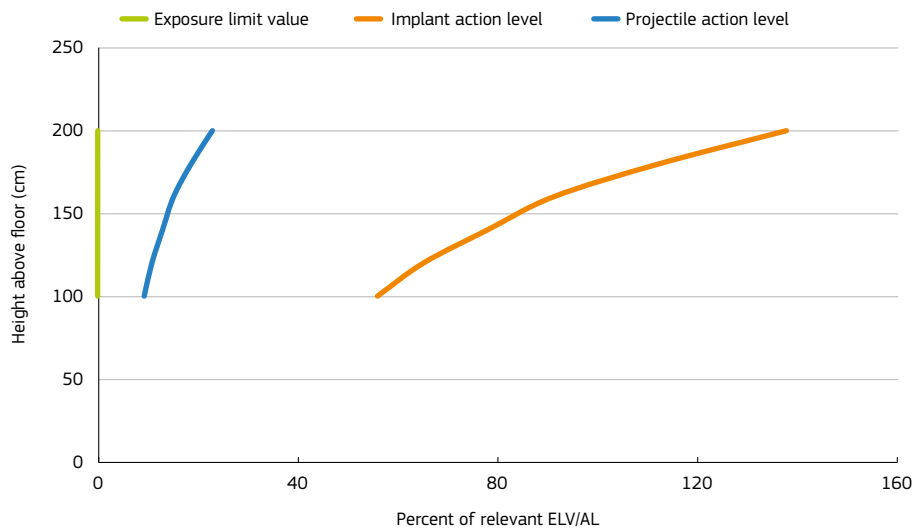
The results from the exposure assessment in the electrolyser cell room provided the company with the following information:

- exposure to magnetic fields from the electrolysers was below the relevant ELVs and direct effects ALs;
- persons fitted with active implanted medical devices may encounter a hazard from static magnetic fields in the cell room;
- the reference levels given in the Council Recommendation (1999/519/EC) were exceeded along the length of the electrolysers in relation to time varying magnetic fields. However, the cell room was unlikely to be occupied by workers at particular risk.

### 3.6.2 Rectifier bay

The following graphs show the variation of magnetic flux density in relation to the applicable ELVs and ALs described above. The frequency of the ripple on the DC supply was confirmed to be 300 Hz, and 50 Hz fields were also detected from the transformer outside.

**Figure 3.14 — Variation of static magnetic flux density with height underneath the bus bar DC isolator**



*NB:* The bus bar DC isolator was approximately 420 cm above ground level.

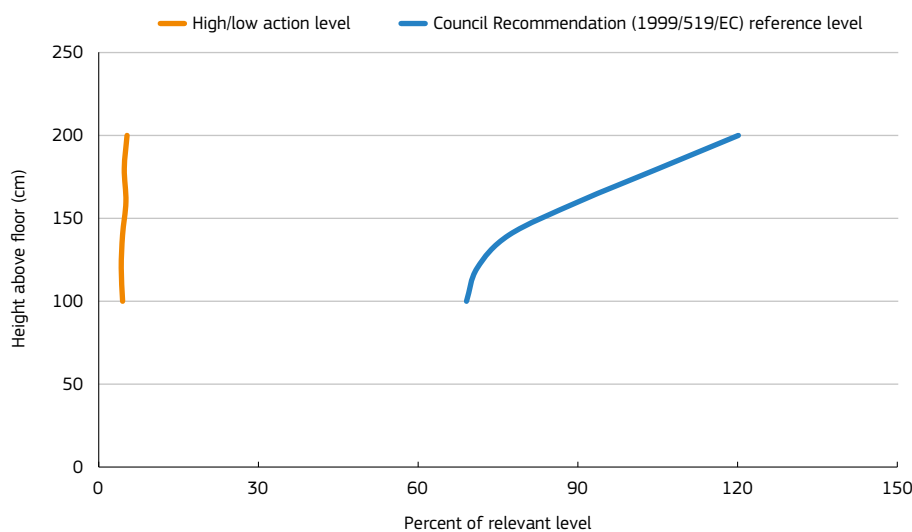
Exposure limit value (normal working conditions): 2 T

Implant action level: 0.5 mT

Projectile action level: 3 mT

The uncertainty in the measurements was estimated to be  $\pm 5\%$  and in accordance with the 'shared risk' approach (see Appendix D5 of Volume 1 of the Guide) the results were taken as direct percentages of the ELV/ALs.

**Figure 3.15 — Variation of 300 Hz time varying magnetic flux density with height underneath the bus bar DC isolator**



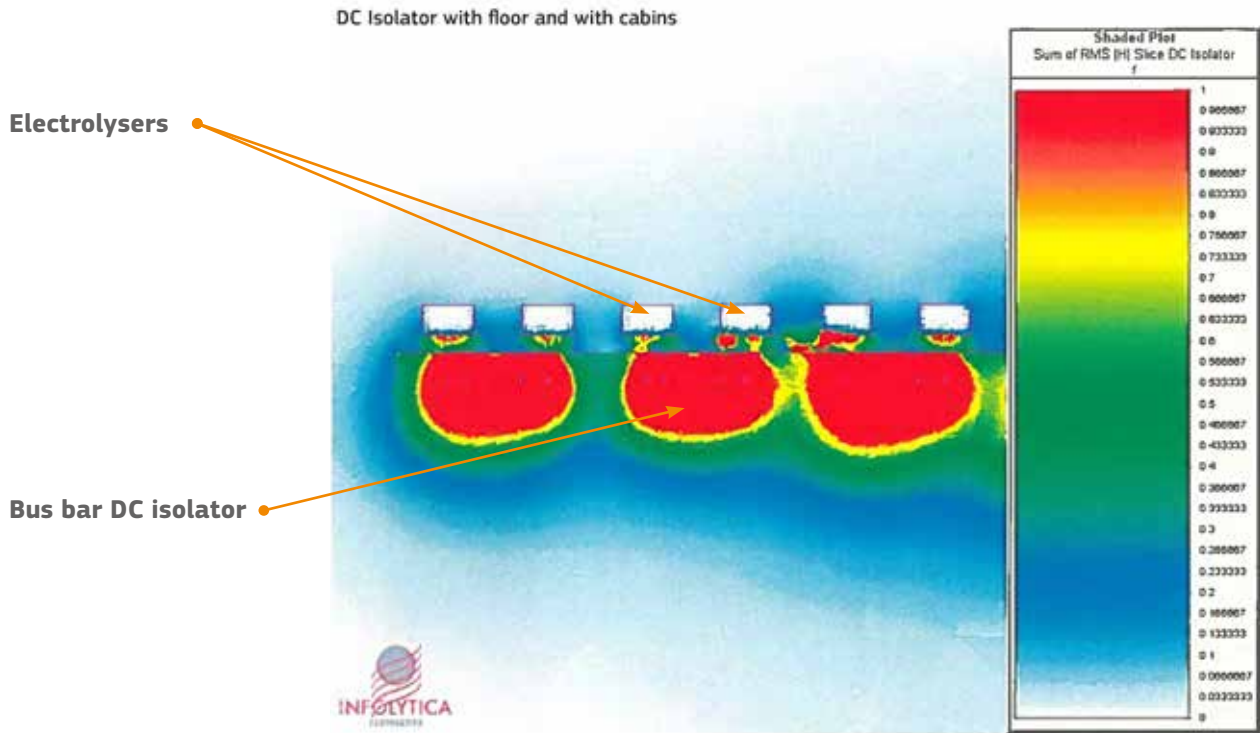
*NB:* The bus bar DC isolator was approximately 420 cm above ground level.

High and low action levels for 300 Hz magnetic field: 1000  $\mu$ T

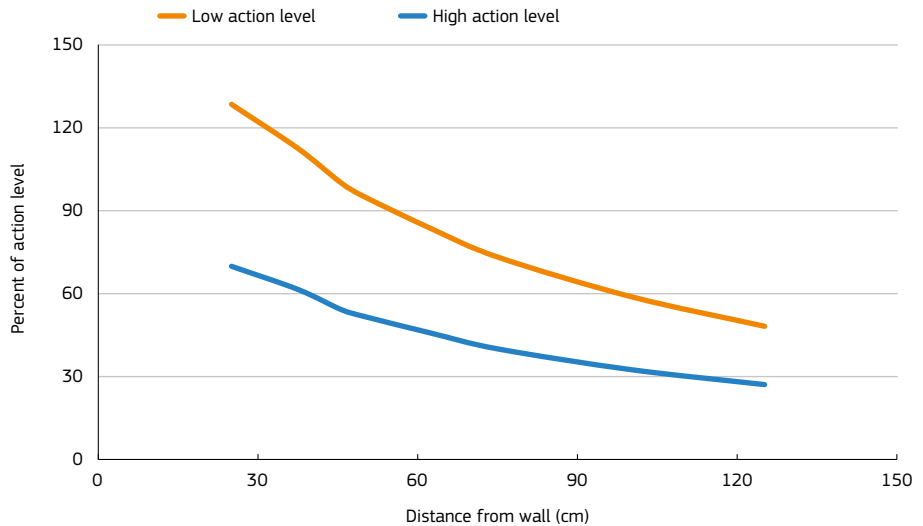
Council Recommendation (1999/519/EC) reference level for 300 Hz magnetic field: 16.7  $\mu$ T

The uncertainty in the measurements was estimated to be  $\pm 10\%$  and in accordance with the 'shared risk' approach (see Appendix D5 of Volume 1 of the Guide) the results were taken as direct percentages of the AL/RL.

**Figure 3.16 — Example of a theoretical modelling assessment diagram for the regions around the bus bar DC isolator (cross section)**



**Figure 3.17 — Variation of 50 Hz time varying magnetic flux density with distance from the wall between the thyristor rectifier and the transformer**



*NB:* Measurements were made at a height of 120 cm above ground level.  
 Low action level for 50 Hz magnetic field: 1000  $\mu$ T  
 High action level for 50 Hz magnetic field: 6000  $\mu$ T  
 The uncertainty in the measurements was estimated to be  $\pm 10\%$  and in accordance with the 'shared risk' approach (see Appendix D5 of Volume 1 of the Guide) the results were taken as direct percentages of the AL/RL.

The results from the exposure assessment in the rectifier bay provided the company with the following information:

- exposure to magnetic fields from the busbars and thyristor rectifiers was below the direct effects action levels at ground level;
- exposure to time varying magnetic fields from the transformer on the other side of the wall behind the rectifier was greater than the low action level for time varying magnetic flux density up to a distance of 37 cm from the surface of the wall inside the rectifier bay;
- exposure to time varying magnetic fields from the transformer was below the high action level for time varying magnetic flux density in the rectifier bay;
- persons fitted with active implanted medical devices may encounter a hazard from static magnetic fields anywhere in the rectifier bays. However, the warning notices and site safety information were considered to be adequate;
- the reference levels given in the Council Recommendation (1999/519/EC) were exceeded in relation to time varying magnetic fields. However, the rectifier bays were unlikely to be occupied by workers at particular risk.

### 3.7 Risk assessment

Based on the exposure assessment performed by the consultant, the company carried out a risk assessment of the chlorine production facility in relation to EMF. This was consistent with the methodology suggested by OiRA (the EU-OSHA's online interactive risk assessment platform). The risk assessment concluded that:

- workers at particular risk may encounter a hazard in the vicinity of the electrolysers;
- workers, including those at particular risk, may encounter a hazard in the rectifier cubicle bays as a result of exposure to magnetic fields.

An example of an EMF specific risk assessment for the chlorine production facility is shown in Table 3.1.





### 3.8 Precautions already in place

EMF safety was a high priority from the early stages of the design of the facility, and so several protection and prevention measures had been incorporated, including:

- the strength of the time varying magnetic fields likely to be generated by the ripple on the DC supply to the electrolyzers was minimised, for example by using 12 pulse rectifiers, as opposed to six pulse rectifiers;
- the facility was of sufficient size to allow areas of strong magnetic fields to be easily segregated from workers;
- appropriate notices warning of the presence of strong magnetic fields were clearly displayed around the facility;
- workers had been made aware of the potential for exposure to EMF and had been instructed to inform the employer if they were fitted with a medical implant.

### 3.9 Additional precautions as a result of the assessment

The exposure assessment confirmed that the facility had been well designed in relation to EMF exposure, and so no additional precautions were necessary as a result of the exposure assessment.

### 3.10 Further information

Euro Chlor Publication — *Electromagnetic Fields in the Chlorine Electrolysis Units. Health Effects, Recommended Limits, Measurement Methods and Possible Prevention Actions*. 2014.

## 4. MEDICAL

### 4.1 Workplace

The medical physics department in a hospital were asked to assess how the implementation of the EMF Directive could impact on the work carried out at the hospital.

### 4.2 Nature of the work

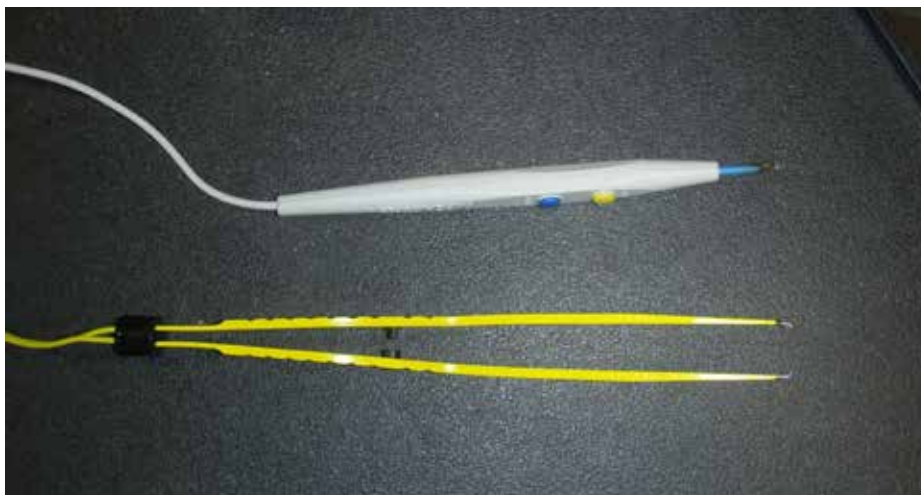
Electrical devices are used extensively in the treatment, monitoring and diagnosis of patients. The medical physics team started their assessment by identifying equipment that could potentially generate strong electromagnetic fields. They reviewed the hospital equipment inventory and identified three items of equipment that they knew to be generators of strong electromagnetic fields; these were electrosurgery units, transcranial magnetic stimulation (TMS) devices and short wave diathermy units. The hospital did not currently use the short wave diathermy equipment, but nevertheless it was included in the assessment. The team also wanted to look at the potential for sensitive patient monitoring equipment to be affected by electromagnetic interference, particularly equipment that may be used in the vicinity of the devices generating strong electromagnetic fields. They identified that the most susceptible equipment to electromagnetic interference would be sensitive medical equipment used during electrosurgery procedures (e.g. ventilators and electrocardiographic devices).

### 4.3 Information on the equipment giving rise to EMF

#### 4.3.1 Electrosurgery units

Electrosurgery devices are used in the hospital for the purposes of cutting and/or coagulation of human tissue, and are used in a significant number of surgical procedures. They work by passing a high voltage electric current through the tissue being operated on. These units typically operate in the intermediate frequency range of approximately 300 kHz to 1 MHz and use powers of 50 to 300 W. An electrosurgery unit comprises of an active electrode, a generator, cables connecting the generator to the active electrode and the return electrode or grounded plate mounted on the patient's body (Figure 4.1). The power is supplied to the active electrode (electrosurgery probe) via cables that may be unshielded. The current passes through the patient's tissue and is returned to the electrosurgery unit via the return electrode.

**Figure 4.1 — Active and return electrodes and associated cables**



### 4.3.2 Transcranial magnetic stimulation

A transcranial magnetic stimulation (TMS) device intentionally produces pulses of electromagnetic fields for the purpose of inducing currents in the [brain](#), and can be used in a number of applications (e.g. in the diagnoses of brain disease and injury, as a treatment for depression and more recently as a treatment for migraine headaches). Typical TMS devices consist of a main unit producing a high current pulse and a hand-held stimulation coil (Figure 4.2). In commercially available devices, energy is stored in large, high voltage capacitors. These capacitors are discharged into the coil using a thyristor, capable of switching large currents in a few seconds. Two coil designs are in widespread use and are used at the hospital; the circular coil and figure-of-eight coil (although other coil designs exist).

**Figure 4.2 — ‘Figure-of-eight’ TMS coil**



### 4.3.3 Short wave diathermy

Short wave diathermy devices emit radiofrequency (RF) radiation, typically at 27.1 MHz. The devices are used for therapeutic treatment of muscles and joints by physiotherapists. There are two modes of operation; capacitive, where the patient is positioned in the RF field between two plate electrodes (Figure 4.3), and inductive, where the electromagnetic field is applied via a coil.

**Figure 4.3 — Capacitive short wave diathermy**



## 4.4 How the applications are used

### 4.4.1 Electrosurgery units

The surgeon will typically hold the treatment probe close to their upper body during use. The cables may be positioned close to operating theatre workers and in particular, close to the hand and arm of the surgeon.

### 4.4.2 Transcranial magnetic stimulation

The coil is placed close to the patient's head, and an electromagnetic pulse or series of pulses will be generated to induce currents in the patient's brain. The probe may be fixed in position or held in position by the clinician (Figure 4.4).

**Figure 4.4 — Circular TMS coil in use**



### 4.4.3 Short wave diathermy

The team was informed that short-wave diathermy was not currently in use at the hospital, although it was used in the past by physiotherapists. They were not fully aware of the working procedures employed when this equipment was used, but decided that they would carry out an assessment if the hospital planned to put this equipment back into use in the future.

## 4.5 Approach to assessment of exposure

The medical physics team was aware that all three of the medical devices identified generate strong electromagnetic fields. However, they were not sure whether these devices generated fields that could result in workers exceeding the exposure limit values (ELVs). They therefore concluded that further assessment was required and measurements of electromagnetic fields would be necessary. The team selected two pieces of equipment for measurements; a ConMed 5000 electrosurgery unit and a 200 MAGSTIM TMS device. They decided not to carry out measurements on any short wave diathermy units at this time.

The medical physics department owns a variety of measurement probes for monitoring electromagnetic fields. The team used an isotropic (three-axis) probe to carry out the measurements. Different probes were required for each piece of equipment due to the differing frequency of the electromagnetic fields generated.

## 4.6 Results from exposure assessment

### 4.6.1 Electrosurgery unit

The ConMed 5000 electrosurgery unit was operated in monopolar mode. This unit can operate in cutting and coagulation mode. However, preliminary measurements found that the electromagnetic fields produced in cutting mode were higher than in coagulation mode, and so the majority of measurements were made in this mode. The frequency of the field was assessed by making a measurement and displaying the waveform on an oscilloscope, and was found to be 391 kHz. The applied power was approximately 200 W.

Measurements of electric and magnetic fields were made around the treatment and return cables. In terms of comparing the measured field with the action levels (ALs), due to the intermediate frequency field, both the ALs for non-thermal and thermal effects are applicable.

The measurement results reported in Table 4.1 show the magnetic field strength at a number of horizontal distances half-way along the treatment cable. From these results, the team extrapolated the magnetic field to 1 cm from the cable and calculated it to be 7 % of the limb AL.

The assessment of the magnetic field around the equipment demonstrated to the team that the exposure of the surgeon, or other medical workers in theatre, would not exceed the ALs in the EMF Directive nor the reference levels given in the Council Recommendation (1999/519/EC).

**Table 4.1 — Magnetic field strength at various distances from the treatment cable as a percentage of the action levels and the reference levels given in the Council Recommendation (1999/519/EC)**

Distance from cable (cm)	Magnetic field strength (Am <sup>-1</sup> )	Magnetic flux density (μT)	Non-thermal effects		Thermal effects	
			Percentage of high/low action levels (%) <sup>1</sup>	Percentage limb action levels (%) <sup>2</sup>	Percentage action level (%) <sup>3</sup>	Percentage of reference levels given in Council Recommendation (1999/519/EC) (%) <sup>4</sup>
10	0.64	0.81	0.81	0.27	16	34
20	0.53	0.67	0.67	0.22	13	29
50	0.26	0.33	0.33	0.11	6.4	14
100	0.09	0.11	0.11	0.04	2.1	4.7
150	0.04	0.05	0.05	0.02	1.0	2.1

<sup>1</sup> Magnetic flux density high/low action level for frequency of 391 kHz: 100 μT

<sup>2</sup> Magnetic flux density limb action level for frequency of 391 kHz: 300 μT

<sup>3</sup> Magnetic flux density action level for frequency of 391 kHz: 5.12 μT

<sup>4</sup> Council Recommendation (1999/519/EC) reference level on magnetic flux density for frequency of 391 kHz: 2.35 μT

*NB:* The uncertainty in the measurements was estimated to be ±2.7 dB and in accordance with the 'shared risk' approach (see Appendix D5 of Volume 1 of the Guide) the results were compared directly with the ALs/RL.

The electric field was measured in a region occupied by the treatment cable and return cable. It was found that the electric field produced by the return cable was significantly higher than that produced by the treatment cable; indicating that the treatment cable is shielded. The electric field strength as a function of distance from the return cable is detailed in Table 4.2. These measurements are for various horizontal distances half-way along the cable. The highest measured field, at 10 cm from the cable, is lower than the action levels. However, the results show that the reference levels given in the Council Recommendation (1999/519/EC) could be exceeded within approximately 20 cm of this cable.

**Table 4.2 Electric field strength at various distances away from the return cable as a percentage of the action levels and the reference levels given in the Council Recommendation (1999/519/EC)**

Distance from cable (cm)	Electric field strength ( $\text{Vm}^{-1}$ )	Non-thermal effects		Thermal effects	
		Percentage of low action level (%) <sup>1</sup>	Percentage high action level (%) <sup>2</sup>	Percentage action level (%) <sup>3</sup>	Percentage of reference levels given in Council Recommendation (1999/519/EC) (%) <sup>4</sup>
10	116	68.2	19.0	19.0	133
20	92.5	54.4	15.2	15.2	106
30	66.8	39.3	11.0	11.0	76.8
50	48.5	28.6	8.0	8.0	55.8
100	11.9	7.0	2.0	2.0	13.7
150	6.55	3.9	1.1	1.1	7.5

<sup>1</sup> Electric field strength low action level for frequencies in the range 3 kHz to 10 MHz:  $170 \text{ Vm}^{-1}$

<sup>2</sup> Electric field strength high action level for frequencies in the range 3 kHz to 10 MHz:  $610 \text{ Vm}^{-1}$

<sup>3</sup> Electric field strength high action level for frequencies in the range 3 kHz to 10 MHz:  $610 \text{ Vm}^{-1}$

<sup>4</sup> Council Recommendation (1999/519/EC) reference level on electric field strength for frequencies in the range 150 kHz to 1 MHz:  $87 \text{ Vm}^{-1}$

NB: The uncertainty in the measurements was estimated to be  $\pm 0.8 \text{ dB}$  and in accordance with the 'shared risk' approach (see Appendix D5 of Volume 1 of the Guide) the results were compared directly with the ALs/RL.

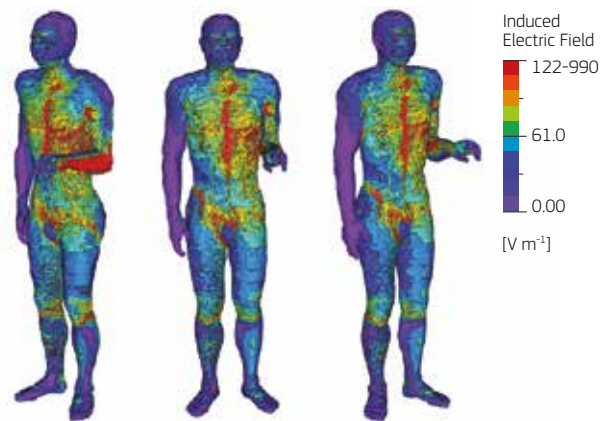
For completeness, the team then used its modelling software for predicting patient exposure, and re-configured it to model the exposure to the surgeon in terms of the ELVs. Both the induced electric fields and SAR values were calculated for the exposure situation where the electrosurgery device is in use and the cables run along the arm of the surgeon at a separation distance of 1 cm.

The induced electric field in various tissues was calculated (Table 4.3). The highest value was calculated to be  $628 \text{ mVm}^{-1}$  in bone. This is 0.6 % of the health effects ELV, confirming to the team that the ELVs for non-thermal effects would not be exceeded by the surgeon. The distribution of induced electric field in a human model is illustrated in Figure 4.5. Of course, it is possible that the cables for the electrosurgery unit could be closer than 1 cm to, or even in contact with, the surgeon. However, the team concluded that the low values of induced electric field mean that the health effects ELV would not be exceeded around the unit under investigation.

**Table 4.3 — Induced electric field as a percentage of the health effects ELV**

Tissue	Induced electric field ( $\text{mVm}^{-1}$ ) <sup>1</sup>	% Health effects ELV
Bone	628	0.60 %
Fat	493	0.47 %
Skin	461	0.44 %
Brain	146	0.14 %
Spinal cord	275	0.26 %
Retina	103	0.10 %

<sup>1</sup> Health effects ELV for internal electric field strength for frequencies in the range 3 kHz to 10 MHz:  $105 \text{ Vm}^{-1}$  (RMS)

**Figure 4.5 — Distribution of the induced electric field in the human model from exposure to the 391 kHz electrosurgery cable**

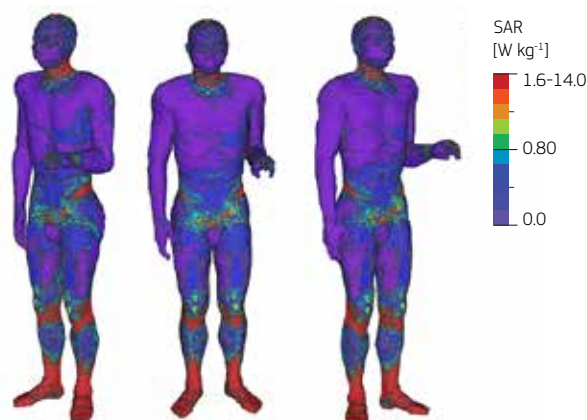
Whole-body and localised SAR values were calculated (Table 4.4), and show that the ELVs would not be exceeded at the surgeon's position. The distribution of SAR in a human model is illustrated (Figure 4.6).

**Table 4.4 — Highest SAR values for the exposure position considered and comparisons with the ELVs**

Position	SAR ( $\text{Wkg}^{-1}$ )	ELV ( $\text{Wkg}^{-1}$ )	% of ELV
Whole-body averaged SAR	0.0338	0.4	8.4
Peak localised 10 g SAR in head and trunk	0.780	10	7.8
Peak localised 10 g SAR in limbs	1.75	20	8.7



**Figure 4.6 — Distribution of specific energy absorption rate (SAR) in the human model from exposure to the 391 kHz field produced by the electro-surgery unit.**



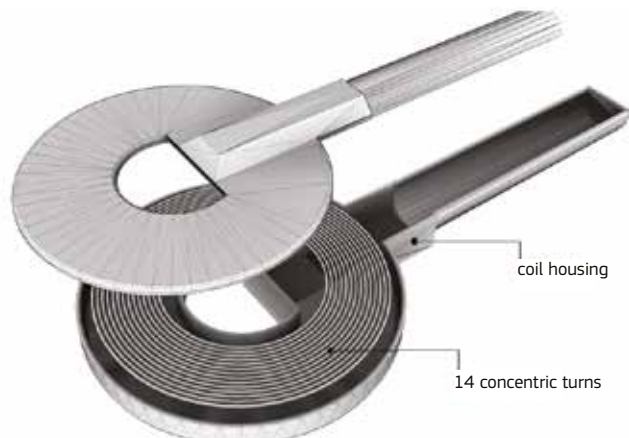
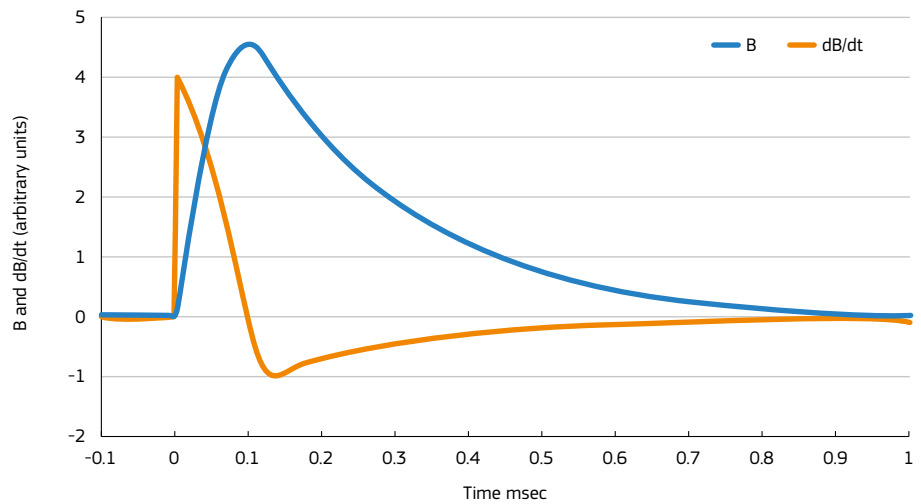
From the assessment, the team was reassured that it was unlikely that the surgeon or other hospital workers would be exposed to fields in excess of the ELVs. However, they recognised the fact that the patient may be exposed to fields in excess of the reference levels given in the Council Recommendation (1999/519/EC), particularly close to the position of the return electrode. This was not generally considered a problem, as the exposure would be a justified part of the surgery. However, it may require consideration if the patient is fitted with an active implanted medical device (AIMD). Another potential risk identified was the electromagnetic interference with sensitive medical devices in the operating room; the team was aware that this had occurred in circumstances where the treatment probe was positioned close to these devices.

#### 4.6.2 TMS device

The 200 MAGSTIM TMS device has two hand pieces, one incorporating a circular coil and another incorporating two circular coils in a 'figure of eight'. The output of the generator is set by the clinician as a percentage of its maximum output. It can be set up to deliver a single pulse, or a series of pulses.

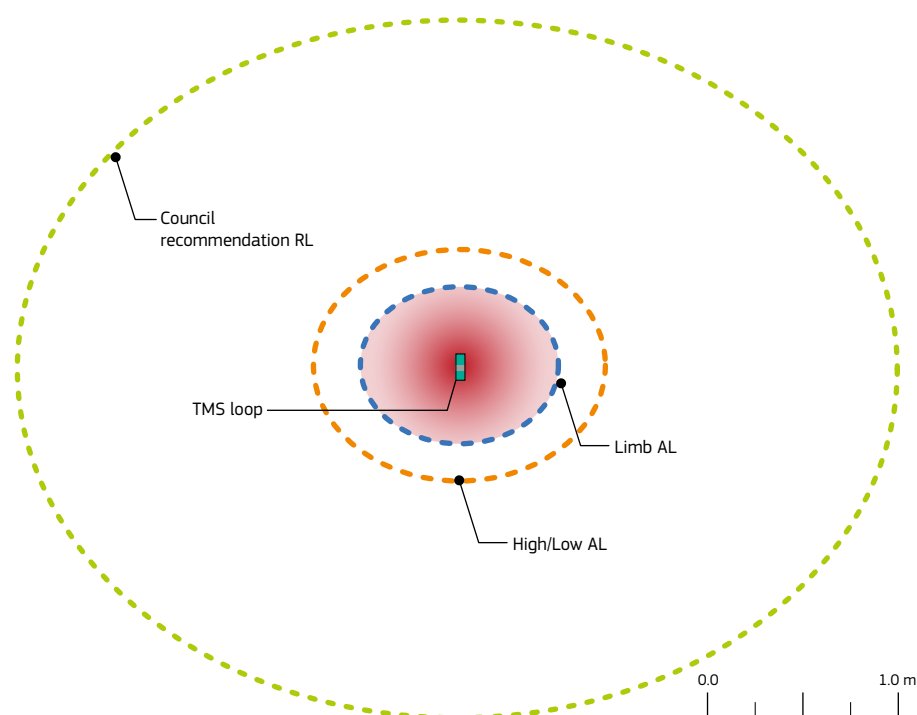
Preliminary measurements found that the circular coil resulted in the highest levels of magnetic fields. This coil (Figure 4.7) is housed in a plastic casing and the coil windings are made of copper, a material selected for its low electrical resistance and high thermal conductivity. The coil is made up of 14 concentric windings, ranging from 70 mm to 122 mm in diameter.

The team carried out measurements using the circular coil, with the generator set at 100 % of its maximum output, and in single pulse mode. The manufacturer provided data on the pulse characteristics (Figure 4.8).

**Figure 4.7 The circular TMS coil****Figure 4.8 —Single pulse characteristics from manufacturer's data**

As expected, the highest fields were measured directly in front of and at the centre of the coil; the areas in which the action levels (ALs) and the reference levels given in the Council Recommendation (1999/519/EC) could be exceeded are shown in Figure 4.9. At the typical operator hand position (holding the hand piece 11 cm below the centre of the coil), the magnetic flux density was measured to be 5600 % of the limb AL.

**Figure 4.9 — Plan view showing the contours within which the limb action level (blue), high/low action levels (red) and reference levels given in the Council Recommendation (1999/519/EC) (green) could be exceeded around the TMS device**



*NB:* The uncertainty in the measurements was estimated to be  $\pm 10\%$  and in accordance with the 'shared risk' approach (see Appendix D5 of Volume 1 of the Guide) the results were compared directly with the ALs/RL when assessing the above distances.

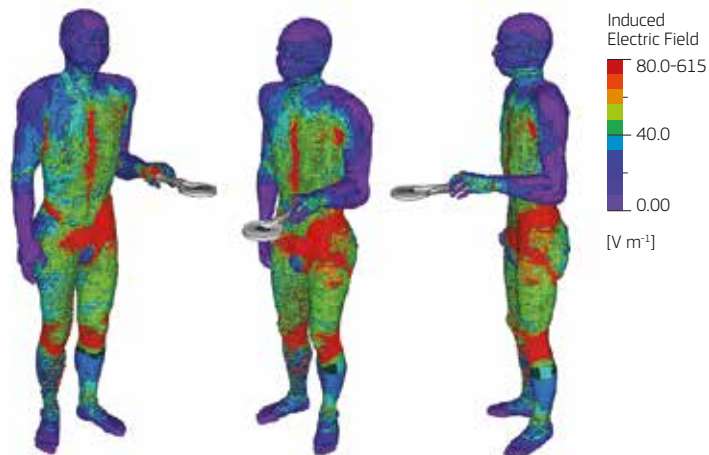
The team realised that the exposure to the clinician was highly likely to exceed the ALs. Again, they carried out computer modelling of the potential exposure to the clinician in terms of the ELVs. The modelling was carried out at two clinician positions; the first with the coil held 30 cm from the body and the second with the coil held 15 cm from the torso. The modelling demonstrated that the ELVs could be exceeded by up to 35 700 % (Table 4.5). The distribution of induced electric field in a human model for both positions is illustrated (Figures 4.10 and 4.11).

**Table 4.5 — Computer modelled values of induced electric field and a comparison with the ELV**

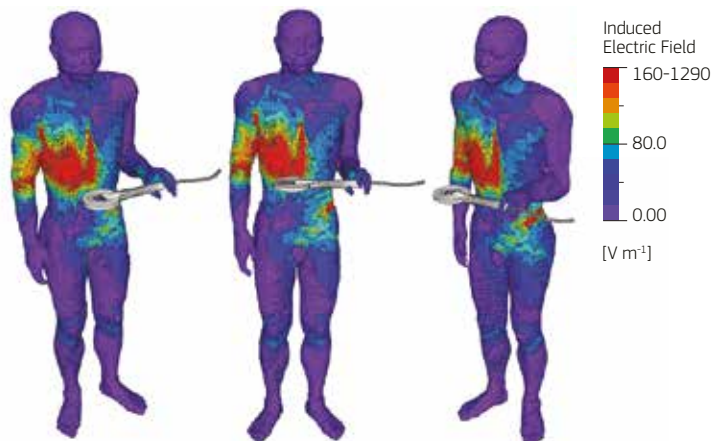
Position	Induced electric field ( $\text{Vm}^{-1}$ )	% Health effects ELV <sup>1</sup>
Coil held 30 cm from the body	265 (bone)	24 100 %
Coil held 15 cm from the torso	393 (bone)	35 700 %

<sup>1</sup> Health effects ELV for internal electric field strength for frequencies in the range 1 Hz to 3 kHz: 1.1  $\text{Vm}^{-1}$  (peak)

**Figure 4.10** — Distribution of the induced electric field in the human model from exposure to the TMS coil when standing with the coil held 30 cm from the body



**Figure 4.11** — Distribution of the induced electric field in the human model from exposure to the TMS coil when standing with the coil held 15 cm from the body



The team concluded that if the probe was held in position by the clinician, the health effects ELV would almost certainly be exceeded. Interference with an AIMD could also potentially be a risk. However, the interference with other hospital devices was regarded as less of a problem than with the electrosurgical unit, as the equipment was not typically used in areas containing sensitive medical devices.

### 4.6.3 Short wave diathermy

Although the team did not carry out an assessment on any of the short wave diathermy units at the hospital, they were aware that these could potentially give rise to high exposures to the physiotherapist and possibly to other workers. Assessments carried out on similar devices at other establishments had concluded that the ALs could be exceeded within approximately 2 m of capacitive short wave diathermy devices and 1 m from inductive short wave diathermy devices. The team decided that a further assessment of their own equipment would be required if it was put back into use. This was so that they could advise the physiotherapists on safe working practices (e.g. safe working distances) and determine whether the reference levels given in the Council Recommendation (1999/519/EC) could be exceeded in areas in which workers at particular risk could enter.

## 4.7 Risk assessment

The hospital carried out risk assessments for the electrosurgery unit (Table 4.6) and the TMS device (Table 4.7) based on the measurements carried out by the medical physics team, which were consistent with the methodology suggested by OiRA (the EU-OSHA's online interactive risk assessment platform). The risk assessments concluded that:

### 4.7.1 Electrosurgery unit

- use of this unit is unlikely to lead to the surgeon or other hospital workers exceeding the ELVs;
- there is potential for electromagnetic interference with AIMDs and other sensitive medical devices in the room.

### 4.7.2 TMS device

- use of this unit is likely to lead to the clinician, and perhaps other hospital workers, exceeding the ELVs, potentially by a significant margin;
- there is potential for electromagnetic interference with AIMDs;
- there is little potential for electromagnetic interference with sensitive medical devices, as the equipment is not used in the vicinity of these devices.

The hospital developed an action plan from the risk assessment and this was documented.

**Table 4.6 — EMF specific risk assessment for electrosurgery unit**

Hazards	Existing preventive and precautionary measures	People at risk	Severity			Likelihood			Risk evaluation	New preventive and precautionary actions
			Minor	Serious	Fatal	Improbable	Possible	Probable		
EMF direct effects	Modelling has demonstrated that the ELVs will not be exceeded by workers	Surgeon and other members of the surgical team	✓			✓			Low	None required
EMF indirect effects (effect on active implanted medical devices (AIMDs) and other sensitive medical devices)	None	Surgeon and other members of the surgical team  Patient		✓			✓		Low	Advise workers on the risk of potential interference with sensitive medical devices  Workers asked to report any instances of interference with medical devices, to the medical physics team  Medical physics team to consider advising surgeons on safe minimum distances of treatment probe and cables to AIMDs and other sensitive medical devices

**Table 4.7 — EMF specific risk assessment for transcranial magnetic stimulator (TMS) device**

Hazards	Existing preventive and precautionary measures	People at risk	Severity			Likelihood			Risk evaluation	New preventive and precautionary actions
			Minor	Serious	Fatal	Improbable	Possible	Probable		
<p>EMF direct effects:</p> <p>The health effects ELVs could be exceeded by the clinician using the equipment</p> <p>The reference levels given in the Council Recommendation (1999/519/EC) could be exceeded up to 235 cm from the probe</p>	None	<p>Clinician</p> <p>Workers at particular risk (pregnant workers)</p>	✓				✓	Medium	<p>Pregnant workers to be prohibited from using the equipment or remaining in the room when the equipment is in use</p> <p>Warning notices to be displayed on the equipment</p> <p>Where possible, mount the probe on a stand</p>	
<p>EMF indirect effects (effect on AIMDs):</p> <p>The reference levels given in the Council Recommendation (1999/519/EC) could be exceeded up to 235 cm from the electrodes</p>	None	Workers at particular risk	✓				✓	Medium	<p>Information regarding this hazard to be given to workers</p> <p>Workers fitted with AIMDs to be prohibited from using the equipment or remaining in the room when the equipment is in use</p> <p>Patients fitted with AIMDs not to be treated with this device</p> <p>Warning and prohibition notices to be displayed on the equipment</p>	

## 4.8 Precautions already in place

Prior to the measurement assessment, there were no specific precautions in place to limit exposure to EMFs.

## 4.9 Additional precautions as a result of the assessment

As a result of the measurement assessment and after an evaluation of the hazards associated with the equipment, the hospital developed an action plan and decided to adopt the following additional precautions:

### 4.9.1 Electrosurgery unit

In relation to the electrosurgery unit:

- advise workers on the risk of potential interference with sensitive medical devices;
- ask workers to report any instances of interference with medical devices, to the medical physics team;
- medical physics team to consider advising clinicians on safe minimum distances of treatment probe and cables to AIMDs and other sensitive medical devices.

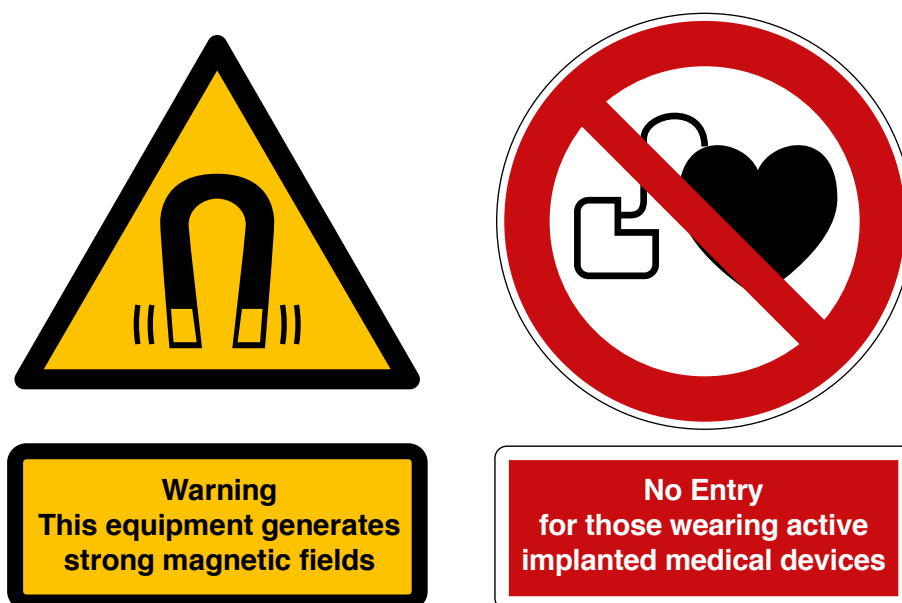
### 4.9.2 TMS device

In relation to the TMS device:

- prohibit pregnant workers and workers fitted with AIMDs from operating the equipment or remaining in the room during treatment;
- do not carry out treatment on patients fitted with AIMDs;
- display notices warning of strong magnetic fields, as well as prohibition notices for AIMD wearers (Figure 4.12);
- if possible, mount the probe on a precision manipulator so that the clinician can stand further away from the probe during treatment;
- if necessary, the medical physics team would consider designing a remote manipulator device to allow the clinician to stand away from the probe during treatment;



**Figure 4.12 — Examples of warning notices for strong magnetic fields and an illustration of the prohibition symbol for AIMD wearers**



### 4.9.3 Short wave diathermy

In relation to short wave diathermy:

- The medical physics team to advise the physiotherapists at the hospital to inform them prior to carrying out short wave diathermy treatments, so that an EMF risk assessment can be carried out and appropriate control measures implemented, if required.

## 5. ENGINEERING WORKSHOP

### 5.1 Workplace

An engineering company wanted to assess how they would be affected by the implementation of the EMF Directive. The company has a variety of electrical equipment in the engineering workshop, including:

- magnetic particle inspection unit,
- demagnetiser,
- surface grinding machine,
- sheet metal guillotine,
- band saw,
- power hacksaw,
- chop saw,
- milling machine (motor),
- pedestal drill,
- hot wire strip heater,
- lathes,
- hand drill,
- grinding wheel.

### 5.2 Nature of the work

The company was aware that some of its equipment, such as the magnetic particle inspection unit used for nondestructive testing, and the demagnetiser used to demagnetise components, are sources of electromagnetic fields. However, the company also wanted to understand whether other tools used could emit significant levels of electromagnetic fields.

### 5.3 How the applications are used

#### 5.3.1 Magnetic particle inspection

Magnetic particle inspection (MPI) (Figure 5.1) is used in the nondestructive testing of metallic components. During MPI, a current is applied to a ferromagnetic work piece in order to magnetise it and defects in the surface of the work piece will perturb the magnetic field that is produced by the current. A ferromagnetic dye applied to the surface of the work piece, when viewed under a suitable light source, allows any defects to be observed. The worker carrying out the inspection of the work piece generally works in close proximity to the equipment.

**Figure 5.1 — Magnetic particle inspection unit**



### 5.3.2 Demagnetiser

The company uses a demagnetiser (Figure 5.2), which is used to demagnetise metal components following the MPI process. The components are loaded manually onto a trolley and rail system that passes through the bore of the demagnetiser coil. The operator pushes the component on the trolley through the demagnetiser by hand. The component is then unloaded from the trolley on the other side of the demagnetiser.

**Figure 5.2 — Demagnetiser with sliding trolley**



### 5.3.3 Surface grinding machine

The surface grinding machine (Figure 5.3) incorporates a rotary table with a static field magnetic chuck on which the components to be ground are fixed. The magnetic chuck can be activated by the operator when the panels of the grinder are open.

**Figure 5.3 — Surface grinding machine**



### 5.3.4 Other tools used in the workshop

The other tools used at the company, which are listed below, are used by a variety of workers on a regular basis:

- sheet metal guillotine,
- band saw,
- power hacksaw,
- chop saw,
- milling machine (motor),
- pedestal drill,
- hot wire strip heater,
- lathes,
- hand drill,
- grinding wheel.

## 5.4 Information on the equipment giving rise to EMF

The company was aware that there could be EMF hazards associated with the MPI unit and the demagnetiser, as the manufacturers' information advises that the equipment could affect pacemakers. However, no further explanation regarding this hazard was provided. The company was unable to find any EMF safety information about the other tools on-site and so consulted the lists of equipment in Table 3.2 in Chapter 3 of Volume 1 of the guide. On this basis it was able to conclude that most of the electric hand tools and smaller electrical equipment were unlikely to present a problem in terms of exposure to EMF.

## 5.5 Approach to assessment of exposure

Due to the lack of information available regarding the EMF hazard associated with the MPI and demagnetiser, the company decided to appoint an expert consultant to carry out a detailed assessment. The company was keen to understand the extent of, and to determine whether there could be hazards associated with any of this equipment.

The consultant made measurements of time varying magnetic flux density around the equipment using an instrument with a built in electronic filter that gives a result, in percentage terms, derived using the weighted peak approach in the time domain, allowing direct comparison with the action levels (ALs). For static magnetic fields, the consultant used a three-axis Hall magnetometer that measured in magnetic field strength.

## 5.6 Results from exposure assessment

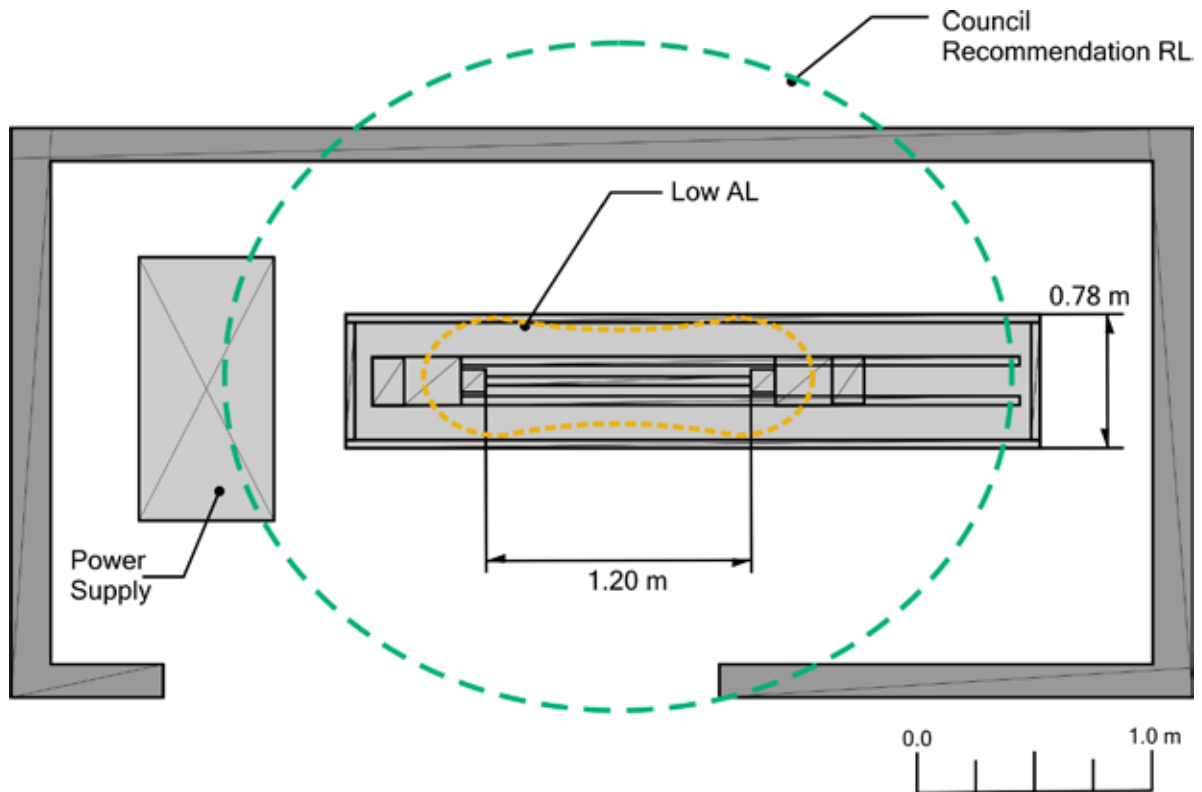
### 5.6.1 Magnetic particle inspection

The MPI unit typically operates at between 1 and 4 kA. Measurements of magnetic flux density were made with the equipment operating at its maximum setting of 10 kA. The equipment was set up in radial magnetisation mode, where the current was applied directly into the work piece. During inspection, the operator was observed to stand at a distance of 60 cm from the work piece, and so measurements were made at this position. The low action level was not exceeded at this position.

Measurements were also made at various other positions around the equipment and the results were compared with the ALs, as well as the reference levels given in the Council Recommendation (1999/519/EC). These levels may be used as a broad indicator for the exposure of workers at particular risk (see Appendix E of Volume 1 of the guide).

The areas in which the ALs and the reference levels given in the Council Recommendation (1999/519/EC) could be exceeded are illustrated (Figure 5.4). The low AL contour is contained entirely within the bed of the machine, whereas the contour relating to the reference levels given in the Council Recommendation (1999/519/EC) extends up to approximately 1.5 m from the work piece and up to 0.4 m into the areas adjacent to the MPI booth.

**Figure 5.4 Plan view showing the contours within which the low action level (yellow) and reference levels given in the Council Recommendation (1999/519/EC) (green) could be exceeded**



### 5.6.2 Demagnetiser

The contractor carried out measurements of magnetic fields around the demagnetiser, which are shown in Table 5.1. The magnetic flux density was found to fall below the low AL at 40 cm from the centre of the bore of the magnet and just exceed the high AL flush with the plane face of the magnet. The reference levels given in the Council Recommendation (1999/519/EC) were exceeded within 1 m of the bore of the magnet.

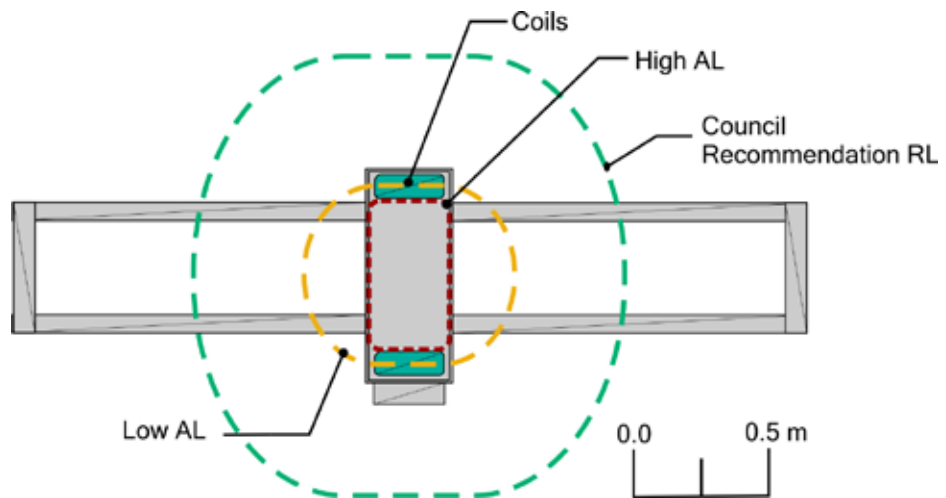
The areas in which the ALs and the reference levels given in the Council Recommendation (1999/519/EC) could be exceeded are illustrated in Figure 5.5.

**Table 5.1 — Magnetic flux densities measured around the demagnetiser expressed as a percentage of the action levels in the EMF Directive**

Measurement position	Measured quantity			Exposure in context of EMF Directive				
	Frequency (Hz)	Magnetic flux density ( $\mu\text{T}$ )	Low action level ( $\mu\text{T}$ )	Exposure (%)	High action level ( $\mu\text{T}$ )	Exposure (%)	Limb action level ( $\mu\text{T}$ )	Exposure (%)
<b>Operator side of trolley rail:</b>								
• Close to RHS of control panel	50	590	1 000	59 %	6 000	10 %	18 000	3.3 %
• Edge of rail alongside magnet	50	1 400	1 000	140 %	6 000	23 %	18 000	7.8 %
• 40 cm from centre of bore of magnet	50	600	1 000	60 %	6 000	10 %	18 000	3.3 %
<b>1 m from centre of bore of magnet (to side of demag unit):</b>								
• Open end	50	70	1 000	7.0 %	6 000	1.2 %	18 000	0.4 %
• Closed end	50	70	1 000	7.0 %	6 000	1.2 %	18 000	0.4 %
<b>Far side of trolley rail (non-control panel side):</b>								
• 25 cm from centre of bore of magnet	50	3 200	1 000	320 %	6 000	53 %	18 000	18 %
• 40 cm from centre of bore of magnet	50	600	1 000	60 %	6 000	10 %	18 000	3.3 %
• 30 cm from magnet casing (isolation switch side)	50	250	1 000	25 %	6 000	4.2 %	18 000	1.4 %
<b>Above trolley rail on axis of magnet bore:</b>								
• Flush with plane face of magnet (open end)	50	6 700	1 000	670 %	6 000	110 %	18 000	37 %
• Flush with plane face of magnet (closed end)	50	6 700	1 000	600 %	6 000	100 %	18 000	33 %

NB: Measurements were made with the instrument in field strength mode, which indicated that the waveform was always dominated by the 50 Hz fundamental frequency. The uncertainty in the measurements was estimated to be  $\pm 10\%$  and in accordance with the 'shared risk' approach (see Appendix D5 of Volume 1 of the Guide) the results were compared directly with the ALs.

**Figure 5.5 — Plan view showing the contours within which the high action level (red), low action level (yellow) and reference levels given in the Council Recommendation (1999/519/EC) (green) could be exceeded around the demagnetiser**



### 5.6.3 Surface grinding machine

Measurements were made around the grinding machine, which incorporates a magnetic chuck to hold the work piece in place.

Measurements around the unit demonstrated that the exposure limit values (ELVs) for exposure to static magnetic fields would not be exceeded at any position. However, the AL for exposure to active implanted medical devices could be exceeded in close proximity to the magnetic chuck (Table 5.2).

**Table 5.2 — Distance at which the magnetic flux density drops to the action level for exposure to active implanted medical devices (0.5 mT)**

Equipment	Distance from side edge of table	Distance from top edge of table
Lumsden grinding machine	15 cm	15 cm

*NB:* The uncertainty in the measurements was estimated to be  $\pm 5\%$  and in accordance with the 'shared risk' approach (see Appendix D5 of Volume 1 of the Guide) the results were compared directly with the AL when assessing the above distances.

### 5.6.4 Other tools used in the workshop

Measurements of magnetic flux density were made around the other power tools in the workshop and the ALs were not exceeded around any of them.

For the tools listed in Table 5.3, the magnetic flux density did not exceed the ALs or the reference levels given in the Council Recommendation (1999/519/EC) at any position. For the tools listed in Table 5.4, the magnetic flux density exceeded the reference levels given in the Council Recommendation (1999/519/EC) in some positions close to the equipment.



**Table 5.3 — Tools that do not present an EMF hazard**

Equipment	Percentage of reference levels given in Council Recommendation (1999/519/EC)
Sheet metal guillotine	33 %
Band saw	<1 %
Power hacksaw	<1 %
Milling machine	50 %
Pedestal drill	20 %
Hot wire strip heater	20 %
Grinding wheel	20 %
Lathes	<2 %

**Table 5.4 — Tools around which the magnetic flux density exceeded the reference levels given in the Council Recommendation (1999/519/EC)**

Equipment	Comments
Chop saw	280 % at surface of the equipment 100 % at 15 cm from motor 20 % at the operator position
Grinding/polishing machine	350 % at surface of the equipment 100 % at 10 cm from the equipment
Hand drill	700 % at surface of the equipment 300 % at typical body position (7 cm from rear of the drill) 100 % at 15 cm from rear of the drill

## 5.7 Risk assessment

The company carried out EMF specific risk assessments for its equipment based on the measurement assessments carried out by the consultant (Tables 5.5 to 5.9). These were consistent with the methodology suggested by OiRA (the EU-OSHA's online interactive risk assessment platform). The risk assessments concluded that:

- MPI unit — the ALs would not be exceeded at the typical operator position. Workers at particular risk could encounter a hazard within approximately 1.5 m of the work piece;
- Demagnetiser — workers could exceed the low AL by standing close to the magnet. Workers at particular risk could encounter a hazard within approximately 1 m of the magnet;
- Surface grinding machine — workers at particular risk could encounter a hazard within approximately 15 cm of the magnetic chuck. However, it was deemed unlikely that a worker would position themselves this close to the magnet;
- Hand drill — workers at particular risk could encounter a hazard when operating this tool;
- Other tools — fields in excess of the reference levels given in the Council Recommendation (1999/519/EC) were measured around some of the tools. However, the fields were very localised, and so the hazard to workers at particular risk was concluded to be low;

The company developed and documented an action plan from the risk assessment.

**Table 5.5 — EMF specific risk assessment for magnetic particle inspection (MPI) unit**

Hazards	Existing preventive and precautionary measures	People at risk	Severity			Likelihood			Risk evaluation	New preventive and precautionary actions
			Minor	Serious	Fatal	Improbable	Possible	Probable		
<p>EMF direct effects:</p> <p>The low action level could be exceeded within the bed of the machine</p> <p>The reference levels given in the Council Recommendation (1999/519/EC) could be exceeded up to 1.5 m from the work piece</p>	<p>The typical operator position is 60 cm from the work piece, meaning that the low action level should not be exceeded at the operator position</p> <p>The equipment is used in a booth</p>	<p>Operators</p> <p>Other workers</p> <p>Workers at particular risk (pregnant workers)</p>	✓				✓	Low	<p>Information and training to be provided to operators and other workers</p> <p>Warning notices to be displayed on equipment</p> <p>Pregnant workers to be prohibited from using the equipment or entering the booth while the equipment is in use</p> <p>Appropriate warning and prohibition notices to be displayed at the entrance to the booth</p>	
<p>EMF indirect effects (effect on active implanted medical devices):</p> <p>The reference levels given in the Council Recommendation (1999/519/EC) could be exceeded up to 1.5 m from the work piece</p>	<p>Workers fitted with active implanted medical devices are prevented from using this equipment</p>	<p>Workers at particular risk</p>	✓				✓	Low	<p>Information regarding this hazard to be given to all workers</p> <p>Warnings to be provided in site safety information</p> <p>Appropriate warning and prohibition notices to be displayed at the entrance to the booth</p>	

Table 5.6 EMF — specific risk assessment for demagnetiser

Hazards	Existing preventive and precautionary measures	People at risk	Severity			Likelihood			Risk evaluation	New preventive and precautionary actions
			Minor	Serious	Fatal	Improbable	Possible	Probable		
EMF direct effects:	None	Operators	✓				✓	Low	Unless it would cause difficulties in using the equipment, install guarding to prevent workers exceeding the low action level and automate some of the more repetitive demagnetisation operations	
The low action level could be exceeded up to 40 cm from the magnet		Workers at particular risk (pregnant workers)							Information and training to be provided to operators and other workers	
The reference levels given in the Council Recommendation (1999/519/EC) could be exceeded up to 1 m from the magnet									Warning notices to be displayed	
									The area in which the reference levels given in the Council Recommendation (1999/519/EC) are exceeded to be demarcated	
									Pregnant workers to be prohibited from entering the demarcated area	
									Appropriate warning and prohibition notices to be displayed at the entrance to the demarcated area	
EMF indirect effects (effect on active implanted medical devices):	Workers fitted with active implanted medical devices are prevented from using this equipment	Workers at particular risk	✓				✓	Low	Information regarding this hazard given to all workers	
The reference levels given in the Council Recommendation (1999/519/EC) could be exceeded up to 1 m from the magnet									Warnings provided in site safety information	
									Appropriate warning and prohibition notices to be displayed at the entrance to the demarcated area	

**Table 5.7 — EMF specific risk assessment for grinding machine**

Hazards	Existing preventive and precautionary measures	People at risk	Severity			Likelihood			Risk evaluation	New preventive and precautionary actions
			Minor	Serious	Fatal	Improbable	Possible	Probable		
Static magnetic field direct effects	None. The ELVs are not exceeded at any position	Operators	✓			✓			Low	None required
Static magnetic field indirect effects (effect on active implanted medical devices):  The action level for exposure to active implanted medical devices could be exceeded up to approximately 15 cm from the magnetic chucks	None	Workers at particular risk		✓			✓		Low. It is unlikely that a worker would position themselves this close to the magnetic chucks	Information regarding this hazard given to equipment operators  Persons fitted with active implanted medical devices to be prohibited from working with the machine when the panels are open  Appropriate warning and prohibition notices to be displayed on the equipment

**Table 5.8 — EMF specific risk assessment for hand drill**

Hazards	Existing preventive and precautionary measures	People at risk	Severity			Likelihood			Risk evaluation	New preventive and precautionary actions
			Minor	Serious	Fatal	Improbable	Possible	Probable		
EMF direct effects:  The reference levels given in the Council Recommendation (1999/519/EC) could be exceeded up to 15 cm from the rear of the drill	None	Operators  Workers at particular risk (pregnant workers)	✓				✓		Low	Pregnant workers to be prohibited from using the hand drill  Information regarding this hazard to be given to workers
EMF indirect effects (effect on active implanted medical devices):  The reference levels given in the Council Recommendation (1999/519/EC) could be exceeded up to 15 cm from the rear of the drill	None	Workers at particular risk		✓			✓		Low	Persons fitted with active implanted medical devices to be prohibited from using this equipment  Information regarding this hazard given to workers

**Table 5.9 — EMF specific risk assessment for other power tools**

Hazards	Existing preventive and precautionary measures	People at risk	Severity			Likelihood			Risk evaluation	New preventive and precautionary actions
			Minor	Serious	Fatal	Improbable	Possible	Probable		
EMF direct effects:  The reference levels given in the Council Recommendation (1999/519/EC) could be exceeded in very localised regions close to the equipment	None	Operators  Workers at particular risk (pregnant workers)	✓			✓			Low. It is highly unlikely that a worker would position themselves this close to the equipment	None required
EMF indirect effects (effect on active implanted medical devices):  The reference levels given in the Council Recommendation (1999/519/EC) could be exceeded in very localised regions close to the equipment	None	Workers at particular risk		✓		✓			Low. It is highly unlikely that a worker would position themselves this close to the equipment	None required

## 5.8 Precautions already in place

Prior to the measurement assessment by the consultant there were very few precautions in place. These were limited to:

- the prohibition of workers fitted with active implanted medical devices using the MPI or the demagnetiser.

## 5.9 Additional precautions as a result of the assessment

As a result of the measurement assessment and after an evaluation of the hazards associated with the equipment, the company developed an action plan and decided to:

- fit four relatively small non-metallic (Perspex) screens on each side of the magnet bore on the demagnetiser. These would be angled inwards so as not to cause significant obstruction, but at all points would be approximately 40 cm from the bore opening of the magnet;

- automate some of the more repetitive demagnetisation operations using robotic handling stages and conveyor belts (Figure 5.6). This had additional benefits in terms of manual handling operations consistent with the requirements of European Directive 90/269/EEC;
- display warning and prohibition notices on the equipment and at the entrance to areas in which the reference levels given in the Council Recommendation (1999/519/EC) could be exceeded, as appropriate. Example warning notices are given (Figure 5.7);
- provide operators with awareness training, and ensure that they are familiar with the findings of the risk assessment and the appropriate protection and prevention measures
- develop appropriate procedures to ensure that all workers, including visitors and contractors, are aware of the potential issues for workers at particular risk (see Appendix E of Volume 1 of the guide)

**Figure 5.6 — Automated demagnetiser with conveyor belt in a robotic handling cell**

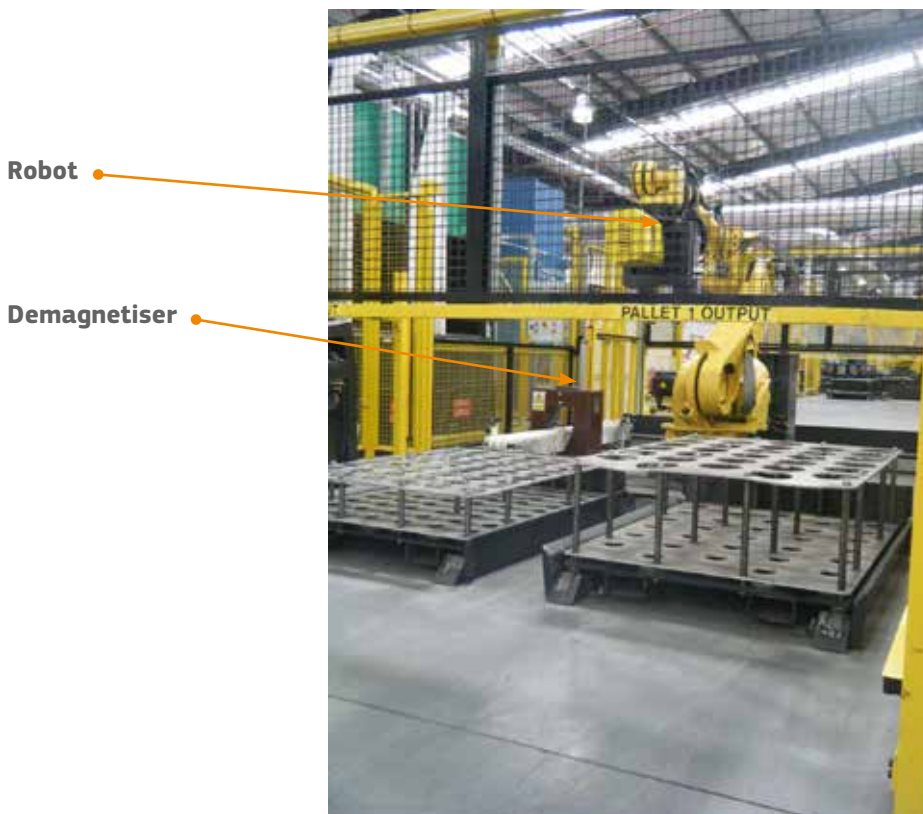
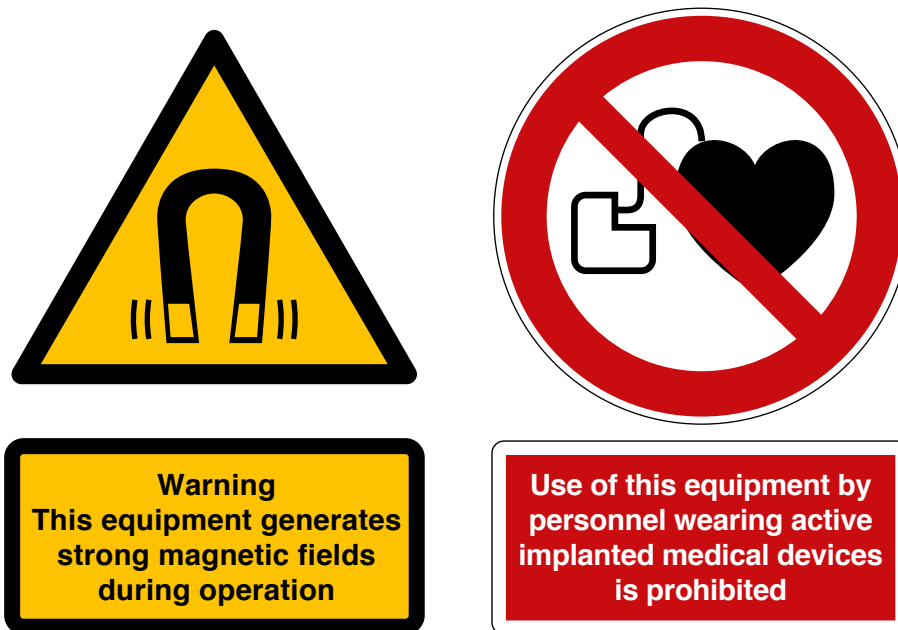


Figure 5.7 — Example of warning and prohibition notices

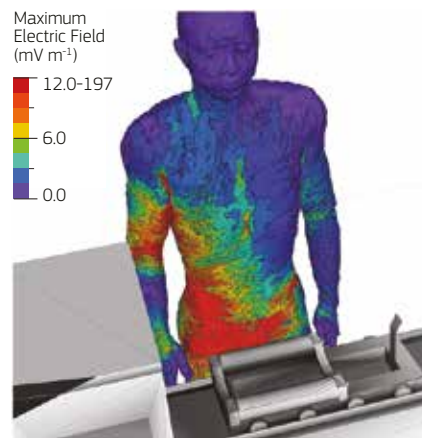


## 5.10 Further information

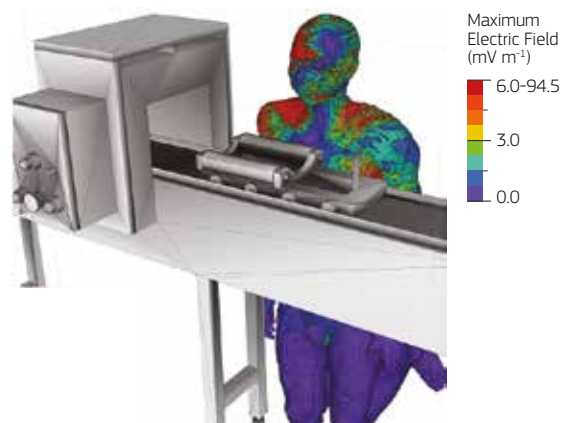
Computer modelling based on the measurement results around the demagnetiser show that, despite the fact that the ALs were exceeded; the induced electric fields were in compliance with the ELVs. For the three exposure situations listed below, the induced electric fields varied from 5 % to 54 % of the low ELV.

- standing in Position 1, 25 cm from the bore of the magnet (Figure 5.8a);
- kneeling in Position 1, 25 cm from the bore of the magnet (Figure 5.8b);
- inclined in Position 2, flush with the bore of the magnet (Figure 5.8c).

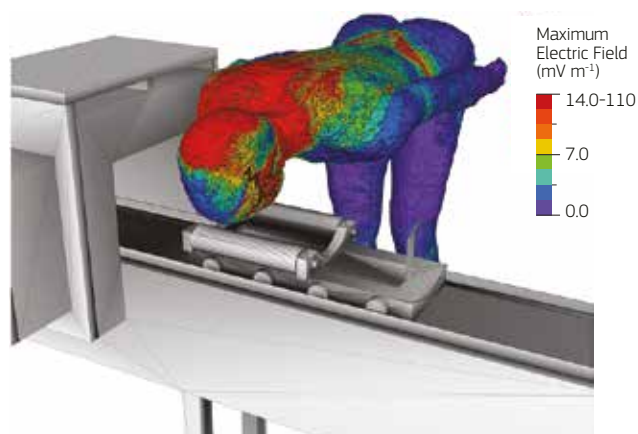
**Figure 5.8a — Distribution of the induced electric field in the human model from exposure to the demagnetiser when standing in Position 1, 25 cm from the bore of the magnet**



**Figure 5.8b — Distribution of the induced electric field in the human model from exposure to the demagnetiser when kneeling in Position 1, 25 cm from the bore of the magnet**



**Figure 5.8c — Distribution of the induced electric field in the human model from exposure to the demagnetiser when inclined in Position 2, flush with the bore of the magnet**





## 6. AUTOMOTIVE

### 6.1 Workplace

This case study covers hand-held spot welders and induction heaters used in a body repair shop. Although not small or medium sized enterprises, the use of spot welders by a leading international vehicle manufacturer is also briefly considered in Section 6.11

### 6.2 Nature of the work

Hand-held spot welders (Figure 6.1) and induction heaters (Figure 6.3) can present a hazard due to strong time-varying magnetic fields produced by the large electrical currents that they use to weld or heat metal. This case study considers two spot welders and three induction heating systems typically used in body repair shops.

**Figure 6.1 — A hand-held spot welder being used to fix a new panel in place**



### 6.3 How the applications are used

Most modern vehicles are produced by welding panels together to create a single shell that the main components are then fixed to. More often than not the welds are made by spot welders. Hand-held spot welders consist of a welding gun connected to a control unit that houses electrical and cooling systems. The gun uses two shaped copper alloy electrodes to produce the spot weld. The size of the electrodes can be varied depending on the location of the spot on the body shell to be welded. An example of one of the body repair shop welders assessed is shown in Figure 6.2.

**Figure 6.2 — A typical body repair shop hand-held spot welder. The system is mobile with the control unit on castors. Electrical and coolant supply cables leave the front of the unit and feed into the rear of the welding gun, which is sitting in its holder to left of the control panel**



During the servicing or repair of vehicles it is common, usually due to corrosion, for workers to have to heat metal components so that they can be removed. Induction heaters consist of an electromagnetic coil through which a low-frequency alternating current is passed. The magnetic field created around the coil induces electric currents, called eddy currents, within the target object and resistance to these currents causes the object to heat up. An example of one of the heaters assessed is shown in Figure 6.3.

**Figure 6.3 — A 1 kW hand-held induction heater being used to heat a seized bolt**



#### **6.4 Information on the equipment giving rise to EMF**

Of the two repair shop welders assessed, one used a 'C-type' gun that could be fitted with either 160 mm or 550 mm arms and one used an 'X-type' gun with either 160 mm or 550 mm electrodes. The different gun types are shown in Figures 6.4 and 6.5. Both welders utilised currents of between 7 500 and 12 000 A and operated at a frequency of 2 kHz. However, whilst the 'C-type' gun used a remote transformer to supply the welding current, the 'X-type' gun utilised a miniaturised transformer within it. This meant that in this welder, the 50/60 Hz mains supply passes along the cable between the control unit and the gun, rather than the much larger welding current. The significance of this is discussed later in this case study.

**Figure 6.4 — The repair shop ‘C-type’ welding gun, with the 160 mm arm fitted. The main body of the gun (under the worker’s hand) contains the piston that forces one electrode onto the other. The welding current is delivered from the control unit by the cables to the left of the picture**



**Figure 6.5 — The repair shop ‘X-type’ welding gun, with 550 mm electrodes fitted. The two electrodes are forced together in a pincer action by a piston in the main body of the gun (between the worker’s hands), which also contains the transformer supplying the welding current**



The three repair shop induction heaters assessed were of varying powers: 1, 4 and 10 kW. The 1 kW heater operated at 15 kHz and the 4 and 10 kW heaters operated between 17 and 40 kHz. The frequency used by the 4 and 10 kW heaters varies because they are able to automatically tune the frequency of the applied current to ensure maximum coupling with the object being heated.

The 1 kW heater consisted of a single handheld unit combining the transformer and heating element in one unit and possessed no active cooling (Figure 6.3). The 4 and 10 kW heaters consisted of a separate power unit and hand-held heating element and had active cooling systems (Figure 6.6).

**Figure 6.6 — The 4 kW (left) and 10 kW (right) induction heaters being used to heat metal components in the repair shop. In these cases the transformer is housed in a separate power unit (left of pictures), with electrical and coolant supply cables connecting the power unit to the heating element (being held by worker in each case). These contrast with the much simpler 1 kW induction heater shown in Figure 6.3**



## 6.5 Approach to assessment of exposure

An automotive industry representative body was concerned about the implications of the EMF Directive on its members; some of which are suppliers of electrical welding and heating equipment. They felt that typical repair shop spot welders and induction heaters could deliver exposures to workers that exceed the relevant action levels in Article 3(2) of the EMF Directive. This was because both spot welders and induction heaters utilise high currents and because workers often hold them close to their bodies during use, as shown in Figures 6.1, 6.4, 6.5 and 6.6.

The body therefore engaged the services of an expert contractor that was involved in a European project to develop guidance on occupational exposures to electromagnetic fields. Arrangements were therefore made for the expert contractor to make an assessment of a range of repair shop equipment in an automotive training college.

The contractor made measurements of time varying magnetic flux density around the welders and heaters described above using an isotropic (three-axis) probe (Figure 6.7). The instrument possessed a built in electronic filter that gave a result, in percentage terms, derived using the weighted peak approach in the time domain and therefore allowed direct comparison with the action levels (ALs) in the EMF Directive. The instrument also had a built in spectrum analyser that allowed the harmonic content of the waveform to be analysed.

**Figure 6.7 — Measurements around the repair shop spot welder fitted with a ‘C-type’ gun and the 160 mm arm installed. The ‘X-type’ gun welder is in the background**



## 6.6 Results from exposure assessments

The measurement results obtained by the contractor are shown in the figures and table below. In all cases, measurements were taken whilst the welder or heater was being used in a manner that was typical of work carried out in a repair shop. Measurements were made to establish the extent of the area around each welding gun and induction heater where:

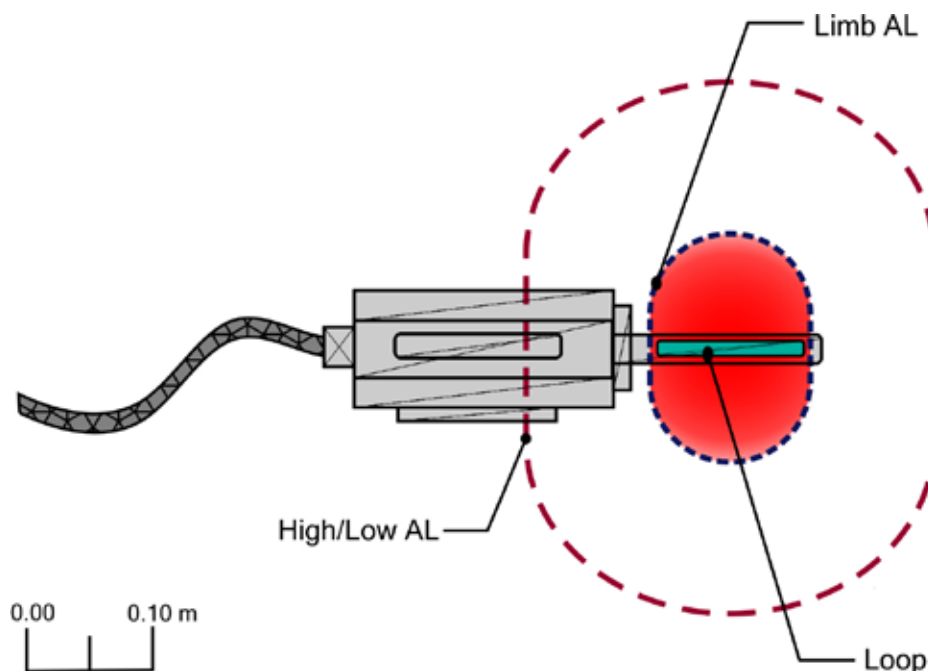
- the ALs in the EMF Directive were exceeded;
- there may be a safety issue for workers at particular risk. This being assessed in the context of the reference levels given in the Council Recommendation (1999/519/EC) (see Appendix E of Volume 1 of the guide)

The spot welders and induction heaters operated between 2 and 36 kHz. In this frequency range the high and low ALs in the EMF Directive are the same. As such, when a measurement of magnetic field strength is shown as a percentage of the action level, it represents the percentage of both the high and low ALs. Where appropriate, measurements are also given as a percentage of the limb AL in the EMF Directive.

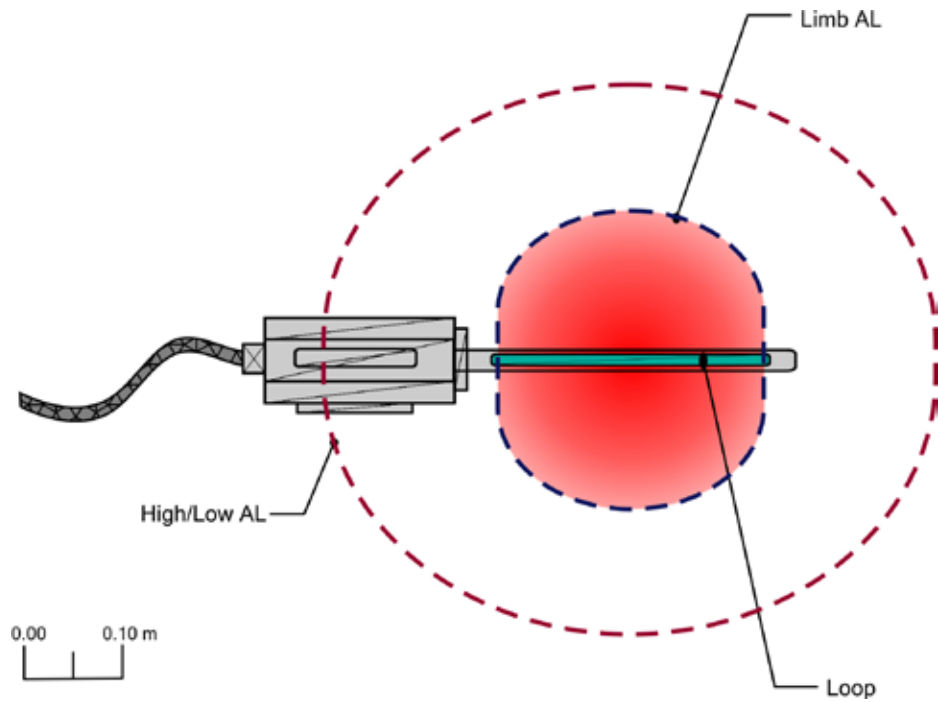
### 6.6.1 Results from exposure assessment of repair shop spot welders

Figures 6.8 to 6.11 show the extent of the areas around each welding gun where either or both the limb or the high and low ALs in the EMF Directive are exceeded. Figure 6.11 also shows the extent of the area around the 'X-type' gun when fitted with 550 mm electrodes, where the reference levels given in the Council Recommendation (1999/519/EC) are exceeded. In all cases, the contours around the guns represent 100 % of the relevant level, where blue represents the limb AL, red represents the high and low AL and green represents the reference levels given in the Council Recommendation (1999/519/EC). In addition, Table 6.1 shows the extent of areas exceeding the relevant ALs around the cable of the 'C-type' welding gun.

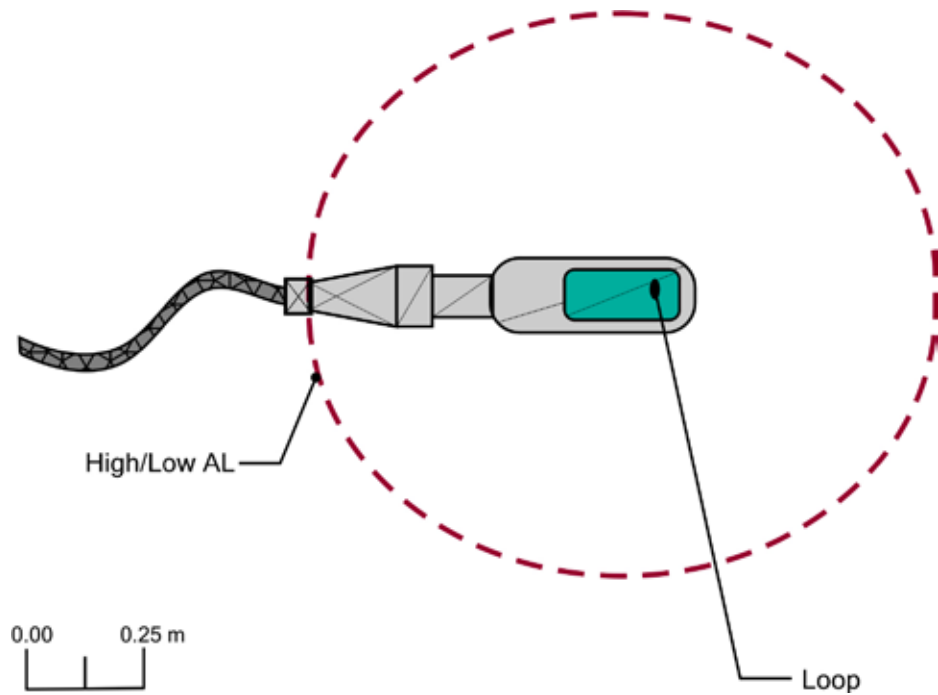
**Figure 6.8 — Plan view showing the contours within which the limb action level (blue) and the high/low action levels (red) could be exceeded around the repair shop 'C-type' gun when fitted with a 160 mm arm**



**Figure 6.9** — Plan view showing the contours within which the limb action level (blue) and the high/low action levels (red) could be exceeded around the repair shop 'C-type' gun when fitted with a 550 mm arm

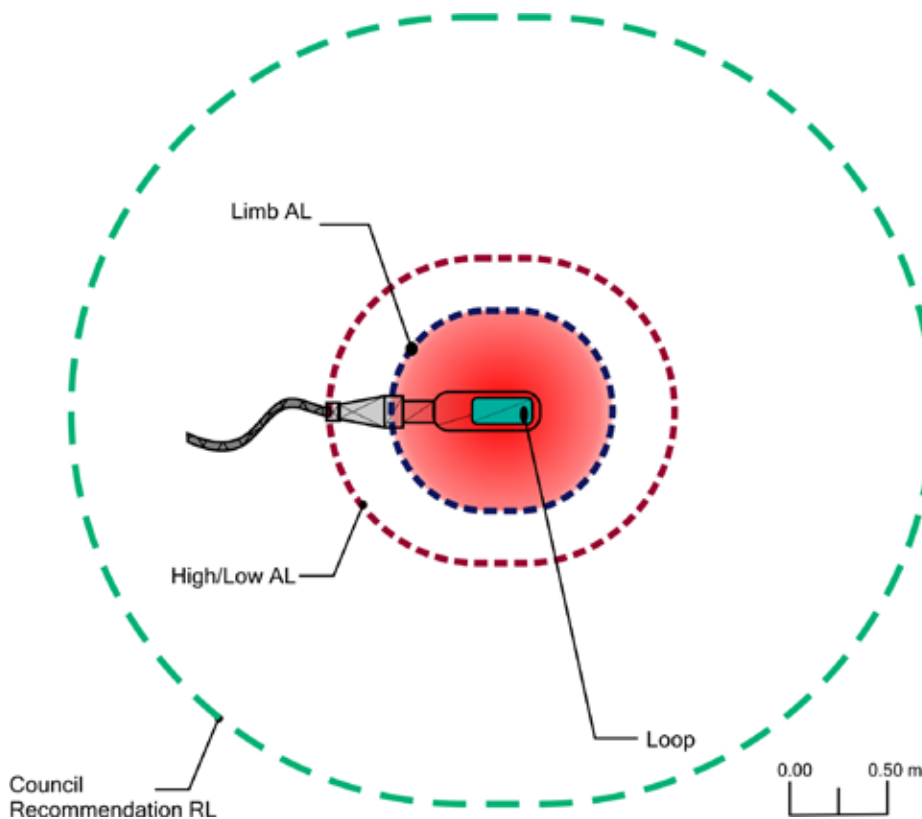


**Figure 6.10** — Plan view showing the contour within which the high/low action levels (red) could be exceeded around the repair shop 'X-type' gun when fitted with 160 mm electrodes





**Figure 6.11 — Plan view showing the contours within which the limb action level (blue), the high/low action levels (red) and the reference levels given in the Council Recommendation (1999/519/EC) (green) could be exceeded around the repair shop 'X-type' gun when fitted with 550 mm electrodes**



**Table 6.1 — Results of measurements on cable between 'C-type' welding gun and control unit**

Clamp type	Current (A)	% of high/low action level <sup>1</sup> 10 cm from cable	% of high/low action level <sup>1</sup> 12 cm from cable	% of limb action level <sup>2</sup> 8 cm from cable
160 mm 'C-type'	8 000	180	100	100

<sup>1</sup> Magnetic flux density high and low action levels for frequency of 2 kHz: 150  $\mu$ T

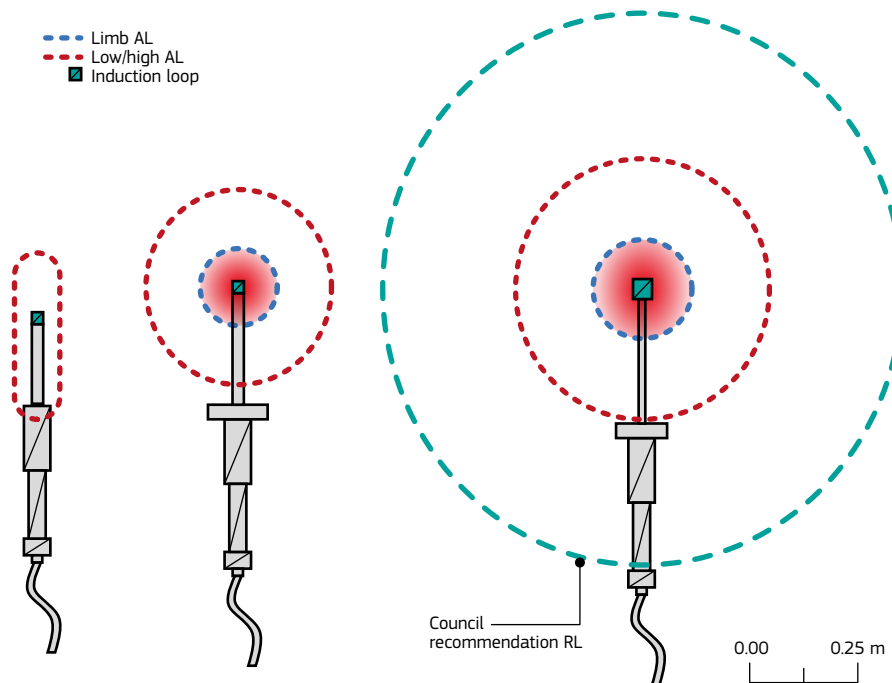
<sup>2</sup> Magnetic flux density limb action levels for frequency of 2 kHz: 450  $\mu$ T

*NB:* The uncertainty in the measurements was estimated to be  $\pm 10\%$  and in accordance with the 'shared risk' approach (see Appendix D5 of Volume 1 of the Guide) the results were taken as direct percentages of the ALs.

## 6.6.2 Results from exposure assessment of induction heaters used in the body repair shop

Figure 6.12 shows the heating elements of the three induction heaters, with the 1 kW heater on the left, the 4 kW heater in the middle and the 10 kW heater on the right. In all cases, the contours around the heating elements represent 100 % of the relevant level, where blue represents the limb AL in the EMF Directive, red represents the high and low ALs in the EMF Directive and green represents the reference levels given in the Council Recommendation (1999/519/EC).

**Figure 6.12 — Plan view showing the contours within which the limb action level (blue), high/low action levels (red) and the reference levels given in the Council Recommendation (1999/519/EC) (green) could be exceeded around the three repair shop induction heaters (1 kW left, 4 kW middle and 10 kW right)**



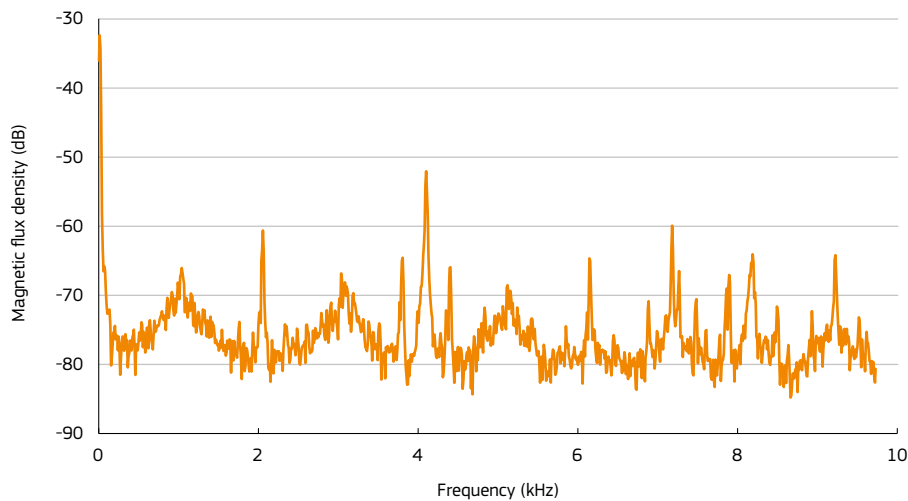
## 6.7 Conclusions of exposure assessments

Depending on the type of gun, the limb AL in the EMF Directive was exceeded between 10 and 22 cm from the clamp, and the high and low AL in the EMF Directive was exceeded between 20 and 32 cm from the clamp. Where measured, the reference levels given in the Council Recommendation (1999/519/EC) were exceeded up to a few metres from the clamp.

The contractor noted that the supply cables for the 'C-type' gun generated magnetic fields around them in excess of the limb AL and the high and low ALs, whereas the 'X-type' gun cables did not. Indeed, the limb AL was exceeded up to 8 cm from the cables and the high and low AL was exceeded up to 12 cm from the cables. The contractor attributed this to the fact that the 'C-type' gun cables carry the welding current from the control unit to the gun, whereas the 'X-type' gun, with the transformer being located within it, has a cable carrying just the 50/60 Hz mains supply.

The contractor confirmed that the fundamental frequency of the welding current for the repair shop spot welders was 2 kHz, though several harmonics made a significant contribution to the overall exposure. To demonstrate this, Figure 6.13 shows the spectral distribution of the waveform obtained from the repair shop welder with the 160 mm 'C-type' gun fitted.

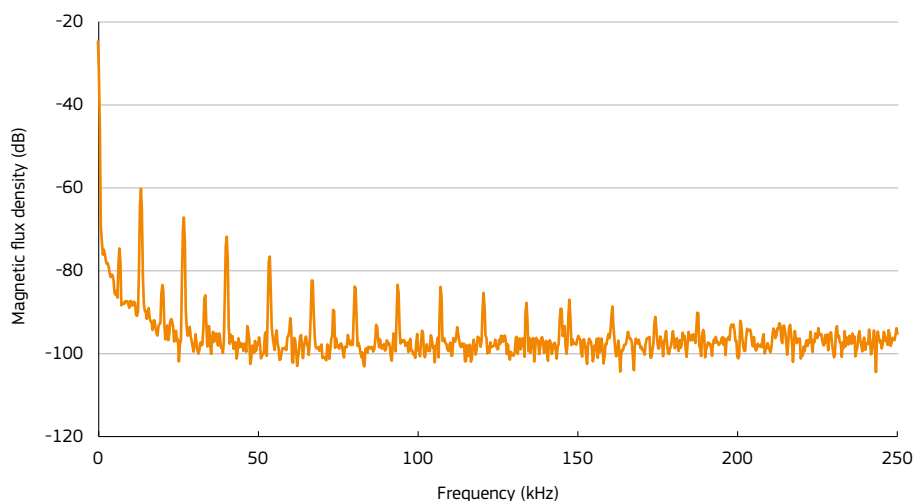
**Figure 6.13 — Spectral distribution of the waveform from the 160 mm ‘C-type’ gun**



With regard to the induction heaters, depending on the power of the heater, the limb AL was exceeded between 7 and 11 cm from the heating element towards the worker's hand, and the high and low AL was exceeded between 13 and 18 cm from the middle of the heating element in all directions.

The fundamental frequency of the heaters varied. The 1 kW heater had a fundamental frequency of 15 kHz and the 4 kW and 10 kW heaters utilised a frequency of 36 kHz. Just like the welders, several harmonics made a significant contribution to the overall exposure in each case. To demonstrate this, Figure 6.14 shows the spectral distribution of the waveform obtained from the 1 kW induction heater.

**Figure 6.14 — Spectral distribution of the waveform from the 1 kW induction heater**



## 6.8 Risk assessment

Given the measurement results, the contractor concluded that, since the spot welding guns are held in the hand, close to the body, the magnetic field exposures received by the workers were likely to exceed the relevant EMF Directive ALs, and potentially also the relevant Exposure Limit Value (ELV). The measurements around the 'C-type' gun's supply cables also indicate that these have the potential to cause exposures in excess of the relevant AL as well.

The contractor also noted that the magnetic fields exceeded the reference levels given in the Council Recommendation (1999/519/EC) up to a few metres from the welding guns. The reference levels may be used as a broad indicator for persons at particular risk from indirect effects of exposure (see Appendix E of Volume 1 of the guide).

With regard to the induction heaters, the contractor concluded that workers using these were not being exposed to fields in excess of the ALs because the heating elements were being kept a sufficient distance away from their hands and body during heating. Nevertheless, the magnetic fields were still sufficient to exceed the reference levels given in the Council Recommendation (1999/519/EC) up to 0.5 m from the 10 kW heater. The contractor therefore recommended that consideration be given to persons at particular risk from indirect effects of exposure to the magnetic fields generated by the heaters (see Appendix E of Volume 1 of the guide).

Given these conclusions, the consultant drafted an EMF specific risk assessment for the use of the spot welders and induction heaters, using the methodology suggested by OiRA (the EU-OSHA's online interactive risk assessment platform). This was to determine what steps should be taken to protect workers to ensure that they are not exposed to magnetic fields in excess of the ALs. The EMF specific risk assessment is shown in Table 6.2.

## 6.9 Precautions already in place

None.

**Table 6.2 — EMF specific risk assessment for use of repair shop hand-held spot welders and induction heaters**

Hazards	Existing preventive and precautionary measures	People at risk	Severity			Likelihood			Risk evaluation	New preventive and precautionary actions
			Minor	Serious	Fatal	Improbable	Possible	Probable		
Low frequency direct effects	None. Hands and body often close to welding clamp to support weight of gun during welding	Workshop workers	✓				✓	Low	Changes to way welding work done — use of balancers to support the weight of the gun to enable workers to keep their hands and body away from the welding electrodes	
	Heating elements of induction heaters usually held at arm's length		✓				✓	Low	Standard operating procedures for welding work  Warning signs on welders and heaters  Operator training on EMF hazard	
		Pregnant workers	✓				✓	Low	Welders/heaters not operated by or near pregnant workers	
Low frequency indirect effects (interference with active implanted medical devices)	None	Workers at particular risk	✓				✓	Low	Welders/heaters not to be operated by or near workers with active implanted medical devices Staff training on EMF hazard	

## 6.10 Additional precautions as a result of the assessments

As a result of the risk assessment, the manager decided to implement the following precautionary measures, including:

- taking steps where possible to ensure workers keep their hands and bodies further back from the spot welder gun and, where necessary, further away from other conductors and supply cables as well. For example, the manager brought in balancers to suspend the spot welding guns from. This meant that the workers no longer had to support the weight of the guns and consequently they could always stand behind the gun and merely hold the rear of the gun to keep it in position during a weld;
- posting notices on the welders and the heaters warning of strong magnetic fields and prohibiting the use of the welder or heater by, or in the presence of, active implanted medical device (AIMD) wearers and other workers at particular risk such as pregnant workers. Examples of those used on the welders in the repair shop are shown in Figure 6.15;

**Figure 6.15 — Examples of strong magnetic fields warning notice and a notice prohibiting the use of the welder by, or in the presence of, AIMD wearers**



- providing information, including the outcome of the risk assessment, to workers;
- providing instruction to workers on how to keep their exposures below the ALs in the EMF Directive
- ensuring, through appropriate induction programmes that other workers are aware of the magnetic field hazard posed by the welders and heaters;
- regularly reviewing the risk assessment.

## 6.11 Spot welders in vehicle manufacture

Although international vehicle manufacturers cannot be considered small or medium sized enterprises, the importance of spot welding to this industry is such that the authors considered it important to include the contractor's assessment of examples of spot welders used by a leading manufacturer.

### 6.11.1 Factory spot welder assessment

Three spot welders were assessed: a 'C-type' gun with a 400 mm arm, an 'X-type' gun with 130 mm long electrodes and an 'X-type' gun with 700 mm long electrodes. The two smaller guns operated at 8 400 A, the largest gun operated at 10 200 A. All three guns had an operating frequency of 50 Hz and were supplied from remote transformers by cables designed to minimise magnetic field exposure. The 400 mm 'C-type' gun and the 700 mm 'X-type' gun are shown in Figures 6.16 and 6.17.

Figure 6.16 — The 400 mm ‘C-type’ gun in the factory. The clamp is held in position using the handles on top of the gun, one of which is visible to the top right of the picture (polished chrome component). This gives an indication as to the position of the operator in relation to the clamp during welding

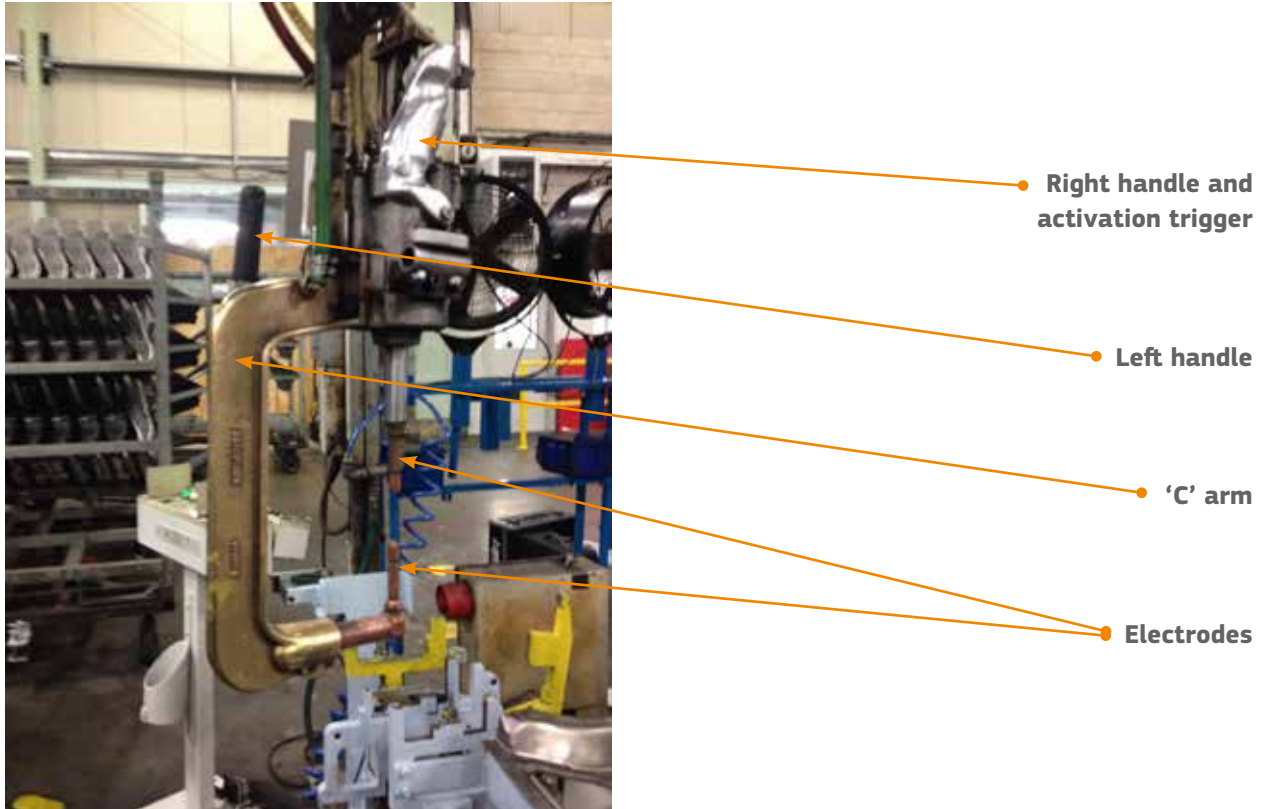
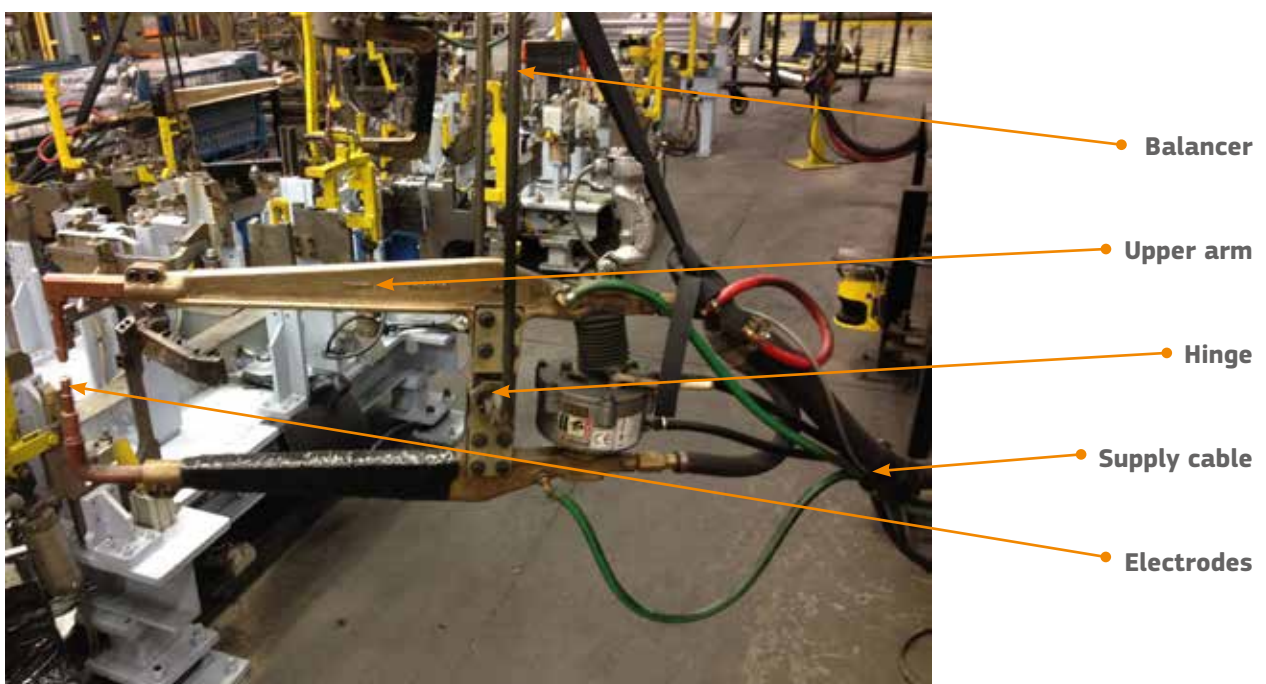


Figure 6.17— The 700 mm ‘X-type’ gun in the factory. Although suspended from a balancer, the size of the gun means that workers have to routinely stand close to the electrodes to guide them and hold them in position



Measurements of time varying magnetic flux density were made around the welding guns using an isotropic (three-axis) probe. The instrument possessed a built in electronic filter that gave a result, in percentage terms, derived using the weighted peak approach in the time domain and therefore allowed direct comparison with the ALs in the EMF Directive. The instrument also had a built in spectrum analyser that allowed the harmonic content of the waveform to be analysed.

The welders operated at 50 Hz. At this frequency the high and low ALs in the EMF Directive are significantly different. As such, measurements of magnetic field strength around the guns are shown as a percentage of both the high and the low ALs.

### 6.11.2 Factory spot welder measurement results

The measurement results obtained are shown in the figures and table below. In all cases, measurements were taken whilst the welder was being used in a manner that was typical of the work being carried out.

Figures 6.18 to 6.20 show the extent of the area around each welding gun where the high and low ALs in the EMF Directive, and the reference levels given in the Council Recommendation (1999/519/EC), were exceeded. In all cases, the contours around the guns represent 100 % of the relevant level, where yellow represents the high AL in the EMF Directive, red represents the low AL in the EMF Directive and green represents the reference levels given in the Council Recommendation (1999/519/EC). In addition to these figures, Table 6.3 shows the result of a measurement around the supply cable of the 'X-type' welding gun.

**Figure 6.18 — Plan view showing the contours within which the low action level (yellow), the high action level (red) and the reference levels given in the Council Recommendation (1999/519/EC) (green) could be exceeded around the 400 mm 'C-type' factory spot welder gun**

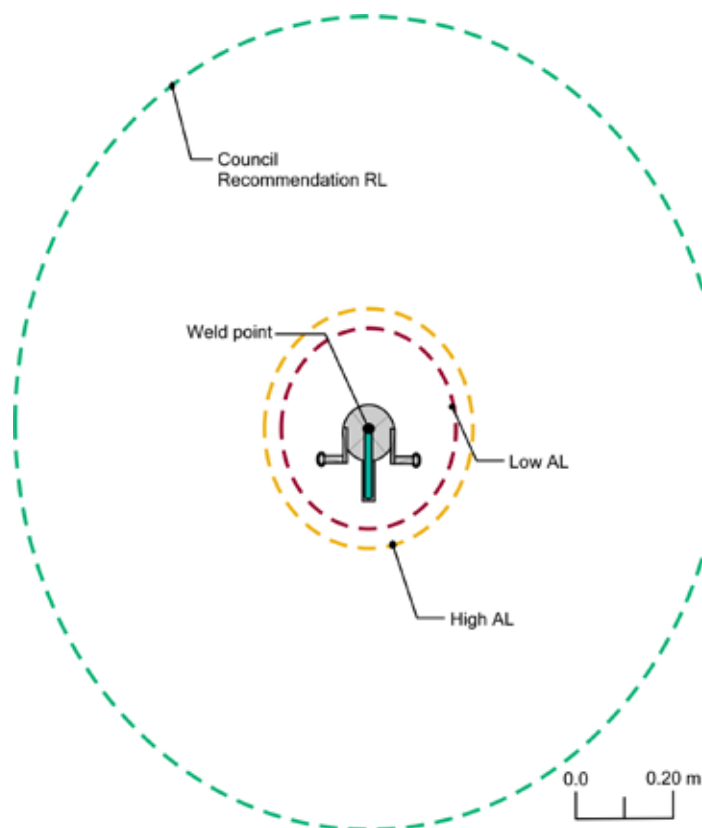




Figure 6.19 — Plan view showing the contours within which the low action level (yellow), the high action level (red) and the reference levels given in the Council Recommendation (1999/519/EC) (green) could be exceeded around the 130 mm 'X-type' factory spot welder gun

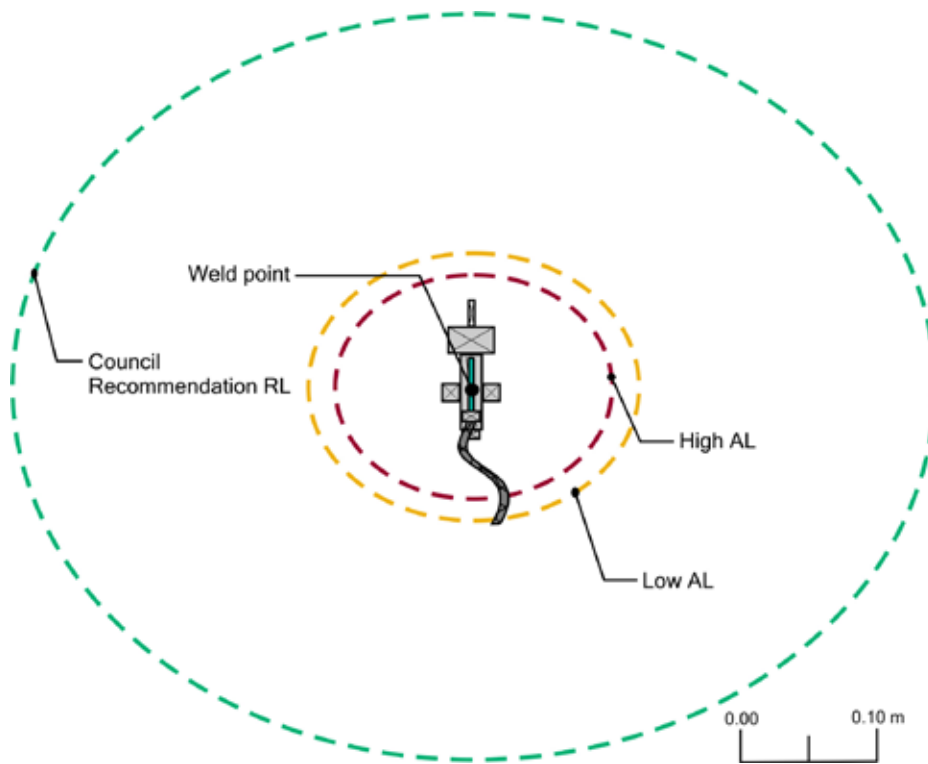
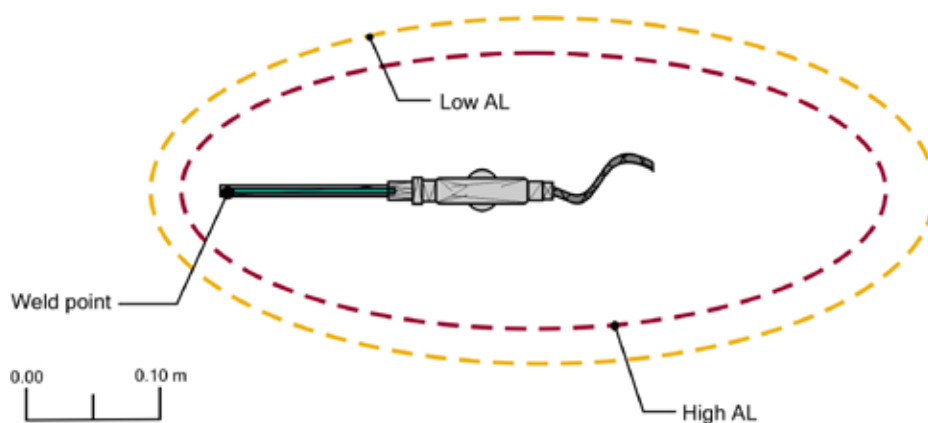


Figure 6.20 — Plan view showing the contours within which the low action level (yellow) and the high action level (red) could be exceeded around the 700 mm 'X-type' factory spot welder gun. In this case the contours are extended behind the gun owing to fields created by conductors at the rear of the gun



**Table 6.3 — Result of measurements on cable between ‘X-type’ welding gun and overhead transformer**

Clamp type	Current (A)	% of low action level <sup>1</sup> 10 cm from cable
130 mm ‘X-type’	8400	12

<sup>1</sup> Magnetic flux density low action level for frequencies in the range 25 to 300 Hz: 1000  $\mu$ T

*NB:* The uncertainty in the measurement was estimated to be  $\pm 10$  % and in accordance with the ‘shared risk’ approach (see Appendix D5 of Volume 1 of the Guide) the result was taken as direct percentage of the AL.

### 6.11.3 Factory spot welder measurement results in the context of the ALs

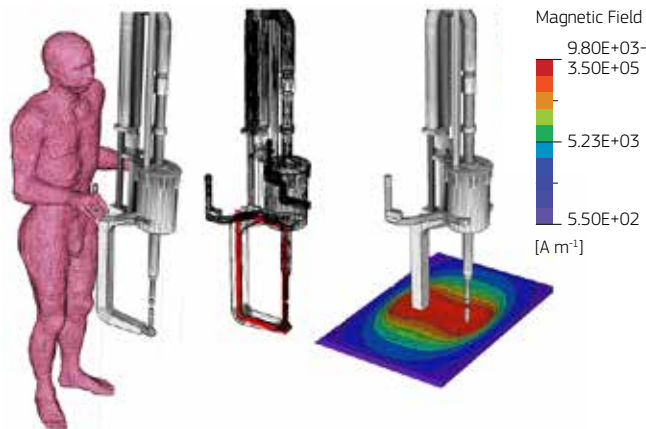
The low AL was exceeded between 37 and 147 cm from the guns and the high AL was exceeded between 27 and 125 cm from the guns. It should be noted that the size of the area exceeding the ALs around the 700 mm ‘X-type’ gun (Figure 6.20) is due not only to the electrodes but also to conductors to the rear of the gun. In addition, the magnetic fields exceeded the reference levels given in the Council Recommendation (1999/519/EC) up to several metres from the welding guns (see Appendix E of Volume 1 of the guide). The gun supply cables had been designed to minimise magnetic field exposures and consequently, as can be seen from Table 6.3, exposure from the cable was well below the low AL.

### 6.11.4 Factory spot welder measurement results in the context of the ELVs

The results indicated that the workers were likely to be receiving exposures far in excess of the relevant ALs, given that they stand within 10 to 20 cm of the guns. However, whilst the employer adopted many of the measures described in section G6.10 of this case study, it was not possible for workers to retreat outside of the areas exceeding the ALs in all cases. In accordance with Article 4 (3) of the EMF Directive, the contractor therefore carried out computer modelling in order to determine whether the relevant ELVs were actually being exceeded.

The contractor used their measurements and observations to produce a model of the 400 mm ‘C-type’ gun. This model was then used to compute the magnetic fields in the areas around the gun, including those occupied by the worker, who was then added to the model. Figure 6.21 shows the final gun and worker models, alongside the gun model showing the current loop (marked in red) used to simulate the magnetic field production and the calculated magnetic field strengths in a selected x-y plane.

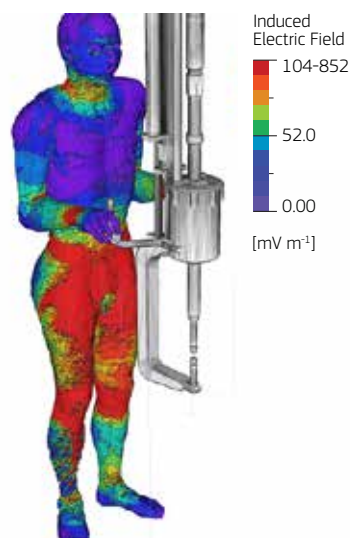
**Figure 6.21 — Models of the 400 mm ‘C-type’ welding gun and the worker operating it (left), the current loop (‘C’ arm, in red) responsible for the magnetic field (middle) and the magnetic field around the gun when operating (right)**



Once the gun and the worker had been modelled, numerical calculations of internal electric fields induced in the body were performed. The results of these calculations, which are based on the body being 15 cm away from the arm of the gun, are shown in Figure 6.22. Red indicates a relatively high electric field, whereas violet indicates a low value. It can be seen that the field is absorbed predominantly in the waist and upper legs of the operator, which are closest to the current loop.

At a distance of 15 cm, the relevant ELVs were not exceeded and so further calculations were performed to determine the distances at which the ELVs would be exceeded. The results of these further calculations are shown in Table 6.4.

**Figure 6.22 — Spatial distribution of the maximum induced electric fields in a human model when exposed to the magnetic fields generated by the 400 mm ‘C-type’ gun**



**Table 6.4 — Maximum internal electric field strength as a proportion of the relevant ELV**

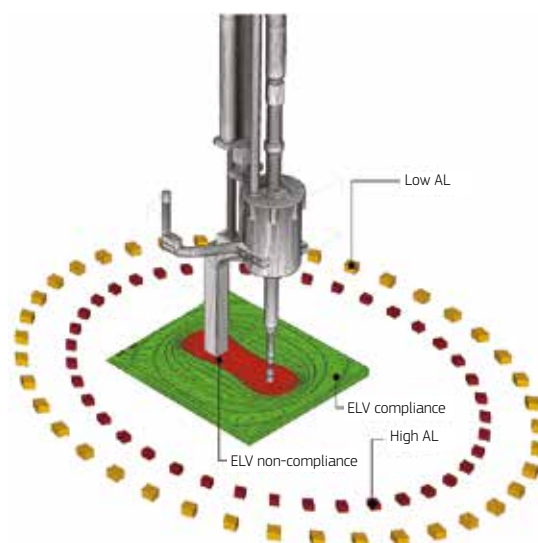
<b>Body trunk to gun separation (cm)</b>	15	7	4
<b>Maximum induced electric field strength in body <math>\text{mV m}^{-1}</math></b>	287	611	811
<b>Percentage of health effects ELV ( %)<sup>1</sup></b>	37	79	104
<b>Maximum induced electric field in central nervous system (<math>\text{mVm}^{-1}</math>)</b>	52	84	92
<b>Percentage of sensory effects ELV ( %)<sup>2</sup></b>	53	85	93

<sup>1</sup> Health effects ELV for frequency of 50 Hz is  $778 \text{ mVm}^{-1}$  (rms)

<sup>2</sup> Sensory effects ELV for frequency of 50 Hz is  $99 \text{ mVm}^{-1}$  (rms)

Table 6.4 shows that when the worker is operating the gun 15 cm from the body, the maximum induced electric field value is  $287 \text{ mVm}^{-1}$ , which represents 37 % of the health effects ELV. For central nervous system tissues in the head, the maximum induced electric field value is  $52 \text{ mVm}^{-1}$ , which represents 53 % of the sensory effects ELV. The results show that the health effects ELV is actually only exceeded when the body to gun distance is reduced to approximately 4 cm. This means that, although workers are being exposed to magnetic fields that exceed the ALs, the internal electric fields induced do not exceed the ELVs. The difference in the size of the areas exceeding the ALs compared to the size of the area in which the worker would actually exceed the health effects ELV is shown in Figure 6.23 below.

**Figure 6.23 — Visual representation of the area around the 400 mm ‘C-type’ gun in which the health effects ELV could be exceeded (red area inside green area), along with the high and low action level contours (red and yellow respectively) from Figure 6.18**



In summary, in this case it appears that the ALs provide a conservative prediction of overexposure and that the exposure situation is actually compliant with the EMF Directive.

## 7. WELDING

### 7.1 Workplace

This case study relates to a metal fabrication workshop, in which a variety of resistance welding machines are used.

### 7.2 Nature of the work

Workers use spot welders and seam welders to weld wires and sheet metal. There are a number of these machines located in the workshop.

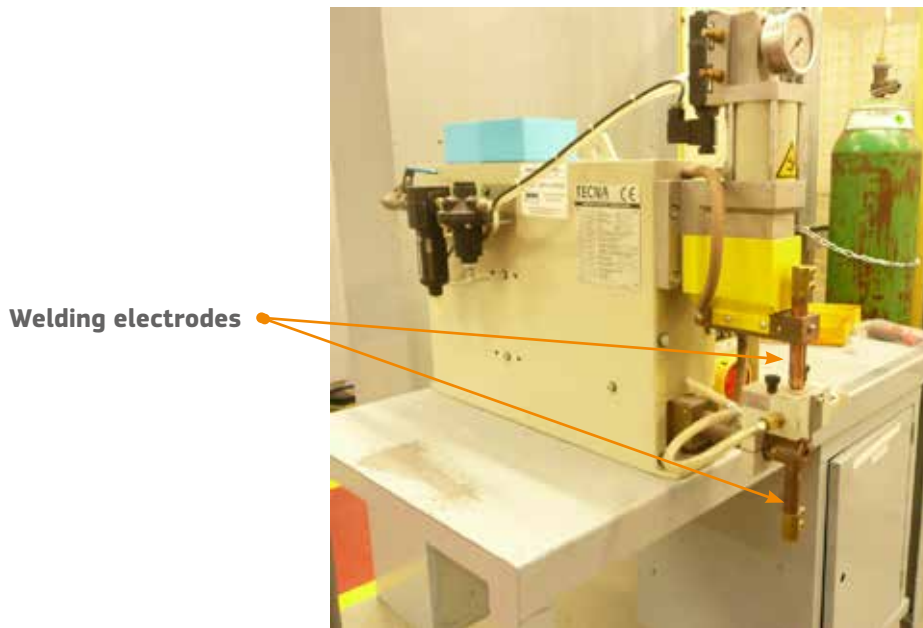
### 7.3 Information on the equipment giving rise to EMF

Resistance welders consist of two electrodes, which clamp together over the components to be welded. A current is passed through the electrodes and components, and the heat required for welding is produced by electrical resistance of the components. The equipment settings are chosen to match the properties of the components to be welded.

#### 7.3.1 Spot welders

The spot welders consist of two small cylindrical electrodes that clamp the components and apply a high current to produce a spot weld. The company uses two types of spot welder: bench-top spot welders and portable suspended spot welders.

The bench-top spot welder (Figure 7.1) is routinely used to weld 1.2 mm trochanter wires made from stainless steel. This equipment has been designed to be used on a bench with the operator positioned in front of the unit. It typically operates at 19 % of the maximum current available (3 500 A), which is 665 A and uses a 50 Hz power supply. The portable suspended spot welder (Figure 7.2) is used to weld together metal sheets. The welder consists of electrode arms, which move in a pincer motion to clamp the electrode tips over the component. It typically operates at 7 000 A and uses a 2 kHz power supply.

**Figure 7.1 — Bench-top spot welder****Figure 7.2 — Portable suspended spot welder**

### 7.3.2 Seam welder

The seam welder is used to weld together pieces of metal. The electrodes are disc shaped and rotate as the material passes between them, meaning that the seam weld is formed progressively. The equipment typically operates at 7 000 A and uses a 50 Hz power supply (Figure 7.3).

**Figure 7.3 — Seam welder front and side views**



## 7.4 How the applications are used

Operators of the welding machines will typically stand or sit next to the machines when welding, with their hands positioned closest to the machines. When using the bench-top spot welder and the seam welder, the operator will hold the material that is being welded, meaning that the hands could be positioned as close as 10 cm from the welding electrodes. When using the portable suspended spot welder, the material to be welded is fixed in position and the operator will stand close to the spot welder, to hold it in position. All of the welding equipment is situated in a workshop along with other machines and tools used in the fabrication of metal components.

## 7.5 Approach to assessment of exposure

The company examined the manufacturers' data for each piece of equipment. There was an indication in some operating manuals that the equipment could produce magnetic fields that present a hazard to pacemaker wearers. However, the company could not find any information on the extent of this hazard (e.g. how far from the equipment this hazard extends) or the level of magnetic fields in the context of the action levels in the EMF Directive. For some of the older equipment, the company could not find any manufacturers' data at all.

The welding equipment is situated in the workshop, to which most workers have access, and which external contractors and visitors could enter. Therefore, the company decided to carry out further assessments of the risks. In the absence of any further information from the manufacturers of the equipment, the company appointed an expert consultant to carry out the assessment.

Three different types of resistance welder were selected for further assessment, as the results would give a good indication of any hazards associated with similar equipment in the workshop. The consultant measured the magnetic flux density around

the equipment using an instrument with a built in electronic filter that gave a result, in percentage terms, derived using the weighted peak approach in the time domain and thereby allowing direct comparison with the ALs.

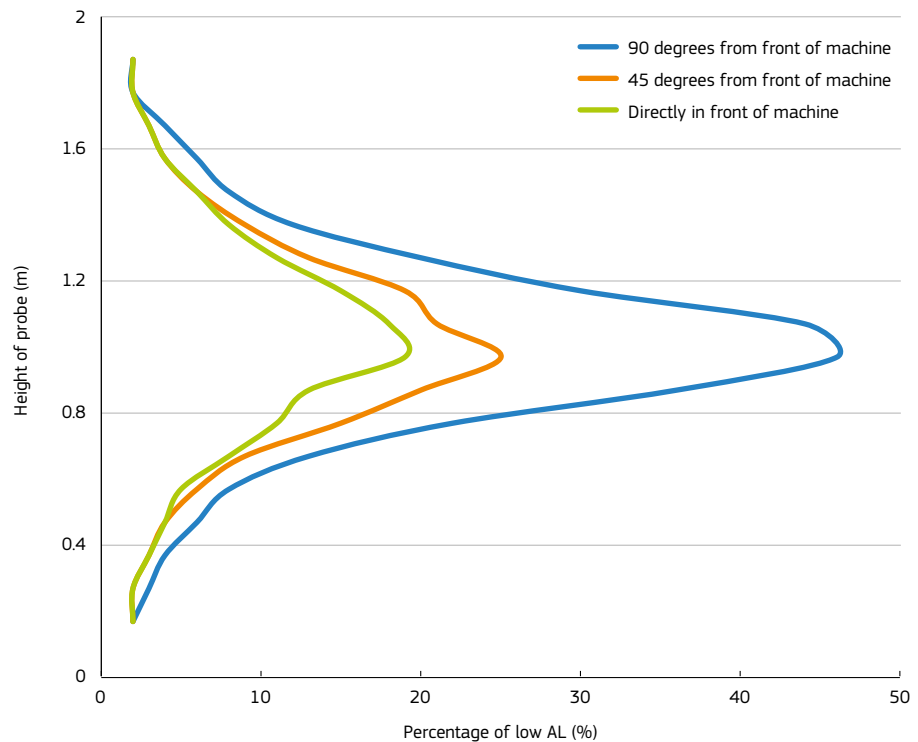
## 7.6 Results from exposure assessment

### 7.6.1 Bench-top spot welder

The consultant observed the operator using the bench-top spot welder. It was noted that the operator's head and trunk remained at least 30 cm from the electrodes during welding, and the operator may be positioned to the side of the equipment rather than directly in front of it. Therefore, measurements were made at three positions 30 cm from the electrodes; directly in front of the electrodes, 45° from the front (to the left hand side) of the electrodes, and 90° from the front (to the left hand side) of the electrodes. At each position, measurements were made at a range of heights.

It was found that the magnetic flux density did not exceed 50 % of the low AL at any of these potential operator positions (Figure 7.4).

**Figure 7.4 — Magnetic flux density as a percentage of the low action level, against height at the operator position (30 cm from the electrodes)**



*NB:* The uncertainty in the measurements was estimated to be  $\pm 10\%$  and in accordance with the 'shared risk' approach (see Appendix D5 of Volume 1 of the Guide) the results were taken as direct percentages of the AL.

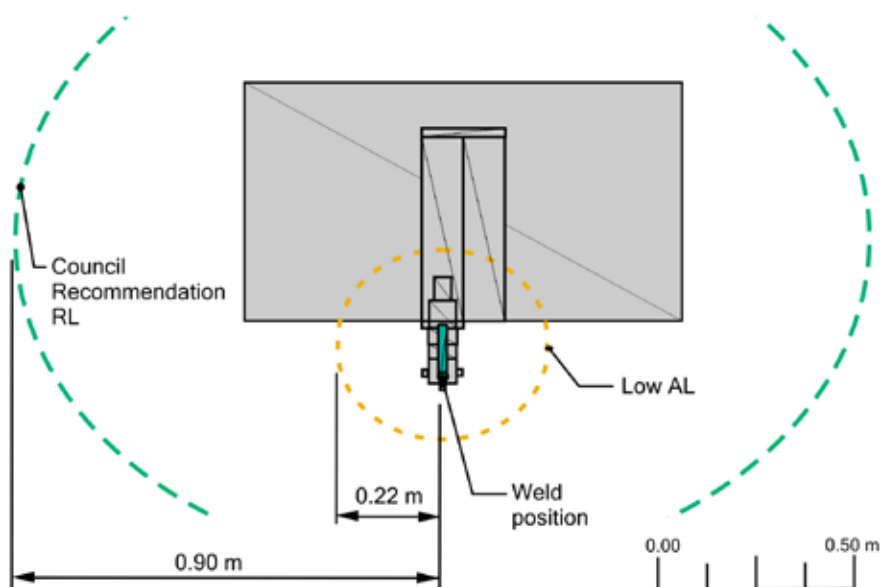


The position at which the magnetic flux density was equal to the low AL, was approximately 22 cm from the electrodes, and at the height at which the electrodes meet. The area in which the low AL could be exceeded is shown in Figure 7.5.

The operator's hands were observed to be at least 10 cm from the electrodes during welding. At this position, the magnetic flux density was less than 8 % of the limb AL.

The consultant made measurements at various other positions around the equipment and compared the results with the reference levels given in the Council Recommendation (1999/519/EC). These levels may be used as a broad indicator for the exposure of workers at particular risk (see Appendix E of Volume 1 of the guide). It was found that the reference levels could be exceeded up to 1 m from the electrodes. This area is shown in Figure 7.5 and is represented by the green contour.

**Figure 7.5 — Plan view showing the contours within which the low action level (yellow) and the reference levels given in the Council Recommendation (1999/519/EC) (green) could be exceeded around the bench-top spot welder**

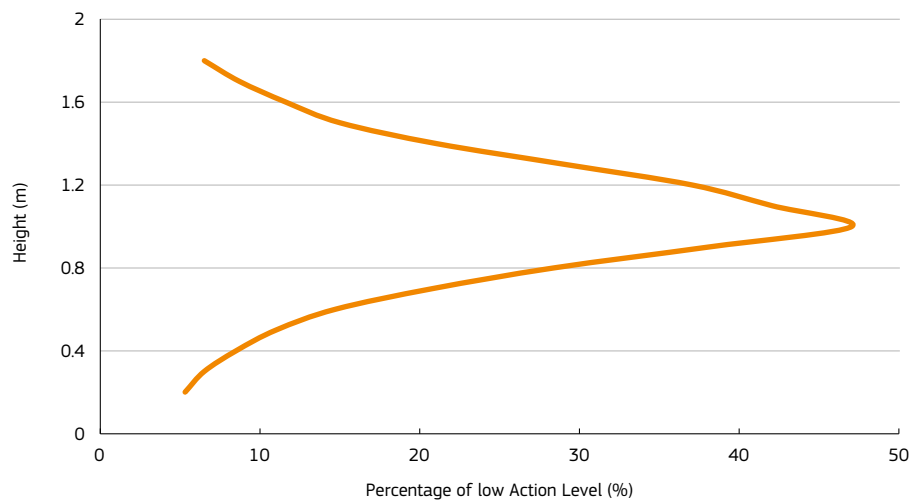


## 7.6.2 Portable suspended spot welder

The operator holds the spot welder in position during welding. Due to the length of the electrode arms (75 cm), the operator stands approximately 1 m from the electrode tips. Measurements were made at this position, at a range of heights.

The highest measurement result was at the height at which the electrodes meet (this was 1 m from the ground during this assessment). It was found that the magnetic flux density did not exceed 50 % of the ALs at the operator position (Figure 7.6).

**Figure 7.6 — Magnetic flux density as a percentage of the high and low action level, against height at the operator position (1 m from the electrode tips)**



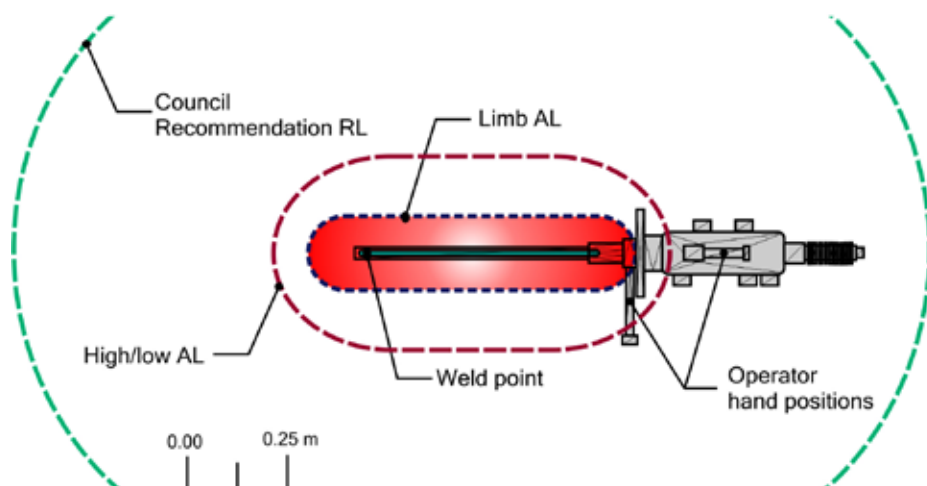
*NB:* The uncertainty in the measurements was estimated to be  $\pm 10\%$  and in accordance with the 'shared risk' approach (see Appendix D5 of Volume 1 of the Guide) the results were taken as direct percentages of the ALs.

Measurements were made at the position of the operator's hand (Figure 7.2). The magnetic flux density was 88 % of the limb AL at this position.

The consultant made measurements at various other positions around the equipment and compared the results with reference levels given in the Council Recommendation (1999/519/EC). It was found that the reference levels could be exceeded up to a maximum of 1.3 m from the equipment.

The areas in which the limb ALs, the high and low ALs, and the reference levels given in the Council Recommendation (1999/519/EC) could be exceeded are shown in Figure 7.7 and are represented by the blue, red and green contours, respectively.

**Figure 7.7 — Plan view showing the contours within which the limb action level (blue), the high and low action levels (red) and reference levels given in the Council Recommendation (1999/519/EC) (green) could be exceeded around the portable suspended spot welder**

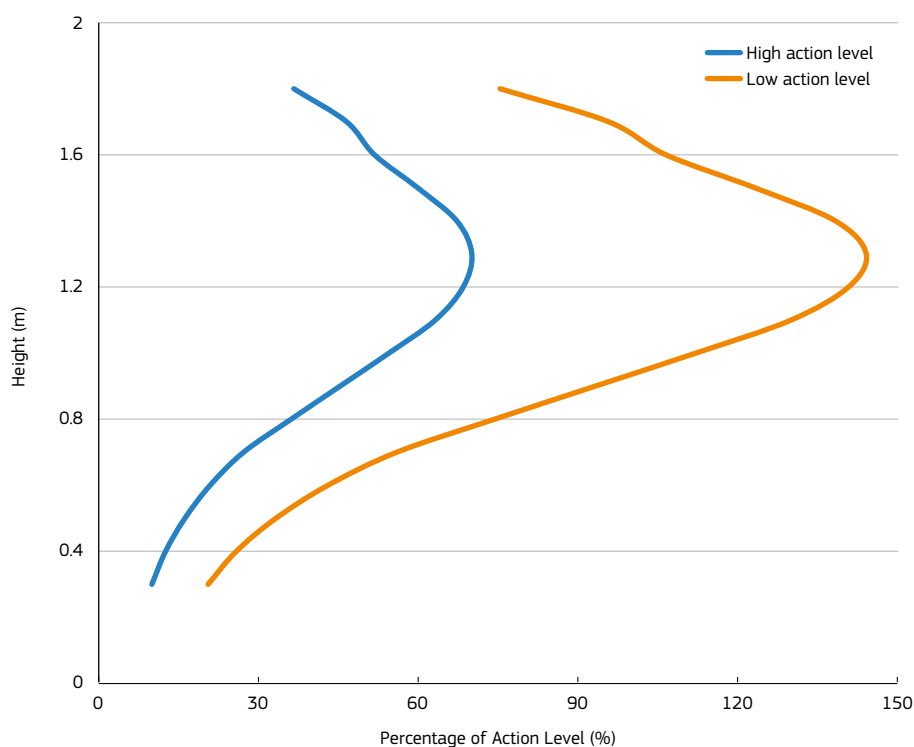


### 7.6.3 Seam welder

The operator stands to the side of the equipment, with the head and trunk at least 50 cm from the centre of the electrodes during welding. Measurements were made at this position, at a range of heights.

The highest measurement result was at the height at which the electrodes meet (130 cm from the ground). The high AL was not exceeded at this position; however, the magnetic flux density was measured to be approximately 140 % of the low AL (Figure 7.8).

**Figure 7.8 — Magnetic flux density as a percentage of the high and low action levels, against height at the operator position (50 cm from the electrodes, to the side)**



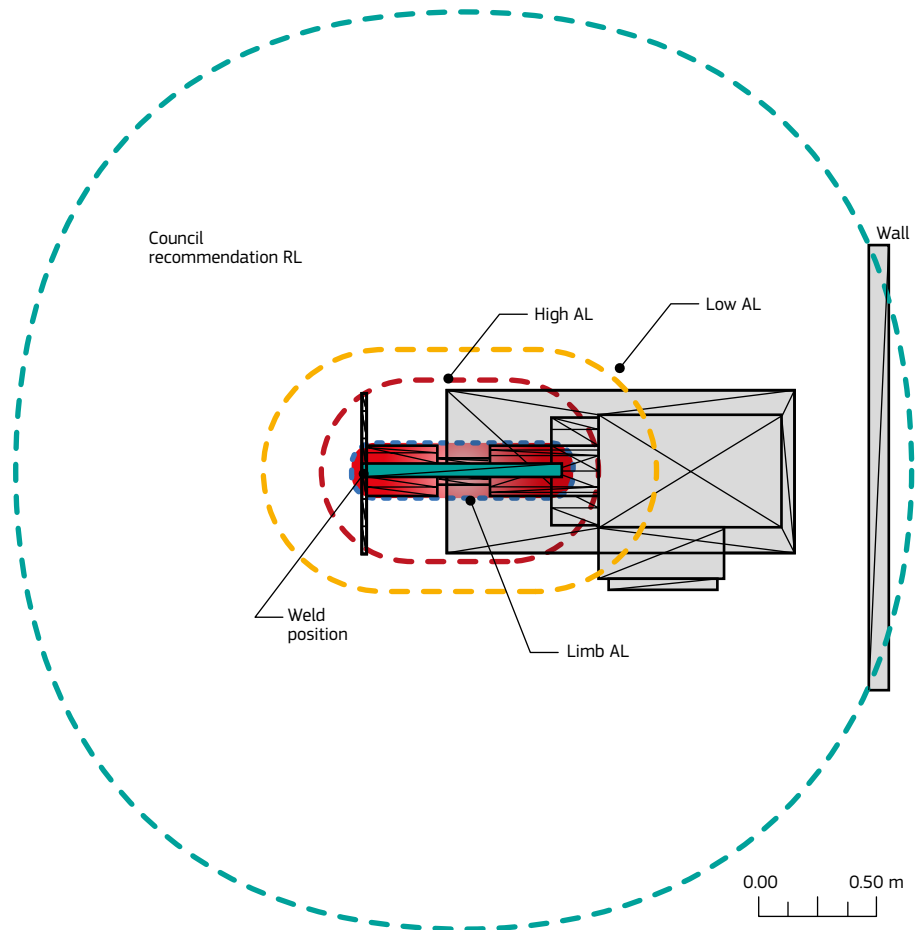
*Note:* The uncertainty in the measurements was estimated to be  $\pm 10\%$  and in accordance with the 'shared risk' approach (see Appendix D5 of Volume 1 of the Guide) the results were taken as direct percentages of the ALs.

Measurements were made at the position of the operator's hand closest to the electrodes (approximately 10 cm from the welding point). The magnetic flux density was less than 67 % of the limb AL at this position. However, it was found that this AL could be exceeded if limbs were positioned behind the welding electrodes, rather than at the sides.

Similar to the spot welder, the consultant made measurements at various other positions around the equipment and compared the results with the reference levels given in the Council Recommendation (1999/519/EC). It was found that the reference levels could be exceeded up to 2.45 m from the electrodes.

The areas in which the limb ALs, the high and low ALs, and the reference levels given in the Council Recommendation (1999/519/EC) could be exceeded are shown in Figure 7.9.

**Figure 7.9 — Plan view showing the contours within which the limb action level (blue), high action level (red), low action level (yellow) and the reference levels given in the Council Recommendation (1999/519/EC) (green) could be exceeded around the seam welder**



## 7.7 Risk assessment

The company carried out EMF specific risk assessments for its welding equipment based on its examination of the operating manuals and the measurements carried out by the consultant (Tables 7.1, 7.2 and 7.3). These were consistent with the methodology suggested by OiRA (the EU-OSHA's online interactive risk assessment platform). The risk assessment concluded that:

- at the typical operator position, the high AL and the limb AL would not be exceeded;
- the low AL could be exceeded at the operator position when working on the seam welder;
- the reference levels given in the Council Recommendation (1999/519/EC) could be exceeded around each welding machine.

The company developed and documented an action plan from the risk assessment.

Table 7.1 — EMF specific risk assessment for bench-top spot welder

Hazards	Existing preventive and precautionary measures	People at risk	Severity			Likelihood			Risk evaluation	New preventive and precautionary actions
			Minor	Serious	Fatal	Improbable	Possible	Probable		
<p>EMF direct effects:</p> <p>The low action level could be exceeded up to 22 cm from the electrodes</p> <p>The reference levels given in the Council Recommendation (1999/519/EC) could be exceeded up to 1 m from the electrodes</p>	<p>The typical operator position is more than 30 cm from the electrodes, meaning that the low action level should not be exceeded at the operator position</p>	<p>Operators</p> <p>Workers at particular risk (pregnant workers)</p>	✓				✓	Low	<p>Information and training to be provided to operators and other persons working in the workshop</p> <p>Warning notices to be displayed on the equipment</p> <p>A demarcation line to be painted on the floor to identify the area in which the reference levels given in the Council Recommendation (1999/519/EC) could be exceeded</p> <p>Pregnant workers to be prohibited from using the equipment or crossing the demarcation line when the equipment is in use</p>	
<p>EMF indirect effects (effect on active implanted medical devices):</p> <p>The reference levels given in the Council Recommendation (1999/519/EC) could be exceeded up to 1 m from the electrodes</p>	None	Workers at particular risk	✓				✓	Low	<p>Information regarding this hazard to be given to all workers</p> <p>Warnings to be provided in site safety information</p> <p>Warning and prohibition notices to be displayed on the equipment</p> <p>Workers fitted with AIMDs to be prohibited from using the equipment or crossing the demarcation line when the equipment is in use</p>	

**Table 7.2 — EMF specific risk assessment for portable suspended spot welder**

Hazards	Existing preventive and precautionary measures	People at risk	Severity			Likelihood			Risk evaluation	New preventive and precautionary actions
			Minor	Serious	Fatal	Improbable	Possible	Probable		
<p>EMF direct effects:</p> <p>The high and low action levels could be exceeded up to 33 cm out from the electrode arms</p> <p>The reference levels given in the Council Recommendation (1999/519/EC) could be exceeded up to 1.3 m from the equipment</p>	<p>None. However, the area in which the high and low action levels are exceeded is localised</p>	<p>Operators</p> <p>Other workers</p> <p>Workers at particular risk (pregnant workers)</p>	✓				✓		<p>Low</p> <p>Information and training to be provided to operators and other persons working in the workshop</p> <p>Warning notices to be displayed on the equipment</p> <p>A demarcation line to be painted on the floor to identify the area in which the reference levels given in the Council Recommendation (1999/519/EC) could be exceeded</p> <p>Pregnant workers to be prohibited from using the equipment or crossing the demarcation line when the equipment is in use</p>	
<p>EMF indirect effects (effect on AIMDs):</p> <p>The reference levels given in the Council Recommendation (1999/519/EC) could be exceeded up to 1.3 m from the electrodes</p>	<p>None</p>	<p>Workers at particular risk</p>	✓				✓		<p>Low</p> <p>Information regarding this hazard to be given to all workers</p> <p>Warnings to be provided in site safety information</p> <p>Warning and prohibition notices to be displayed on the equipment</p> <p>Workers fitted with AIMDs to be prohibited from using the equipment or crossing the demarcation line when the equipment is in use</p>	

Table 7.3 — EMF specific risk assessment for seam welder

Hazards	Existing preventive and precautionary measures	People at risk	Severity			Likelihood			Risk evaluation	New preventive and precautionary actions
			Minor	Serious	Fatal	Improbable	Possible	Probable		
<p>EMF direct effects:</p> <p>The low AL is exceeded at the operator position</p> <p>The reference levels given in the Council Recommendation (1999/519/EC) could be exceeded up to 2.45 m from the electrodes</p>	None	<p>Operators</p> <p>Other workers</p> <p>Workers at particular risk (pregnant workers)</p>	✓				✓	Low	<p>Information and training to be provided to operators and other workers, in particular with regard to potential sensory effects and the need to report any experience of these effects</p> <p>Warning notices to be displayed on equipment</p> <p>A demarcation line to be painted on the floor to identify the area in which the reference levels given in the Council Recommendation (1999/519/EC) could be exceeded</p> <p>Pregnant workers to be prohibited from using the equipment or crossing the demarcation line when the equipment is in use</p>	
<p>EMF indirect effects (effect on AIMDs):</p> <p>The reference levels given in the Council Recommendation (1999/519/EC) could be exceeded up to 2.45 m from the electrodes</p>	None	Workers at particular risk	✓				✓	Low	<p>Information regarding this hazard to be given to all workers</p> <p>Warnings to be provided in site safety information</p> <p>Warning and prohibition notices to be displayed on the equipment</p> <p>Workers fitted with AIMDs to be prohibited from using the equipment or crossing the demarcation line when the equipment is in use</p>	

## 7.8 Precautions already in place

Prior to the measurement assessment by the consultant there were no specific precautions in place to limit exposure to EMFs.

## 7.9 Additional precautions as a result of the assessment

As a result of the measurement assessment and after an evaluation of the hazards associated with the equipment, the company developed an action plan and decided to:

- provide information to workers regarding the EMF hazard associated with the welding equipment;
- paint demarcation lines on the floor around the equipment to indicate where the reference levels given in the Council Recommendation (1999/519/EC) could be exceeded;
- prohibit pregnant workers and workers fitted with AIMDs from using the welding equipment or crossing the demarcation lines;
- post notices warning of strong magnetic fields, as well as prohibition notices for AIMD wearers (Figure 7.10) on the welding equipment;
- ensure, through appropriate site induction programmes and liaison with contractors that persons entering the workshop are aware of the risks.

**Figure 7.10 — Examples of warning notices for strong magnetic and an illustration of the prohibition symbol for AIMD wearers**



**Warning**  
**This equipment generates**  
**strong magnetic fields**  
**during operation**



**Do not cross the yellow**  
**line during welding**



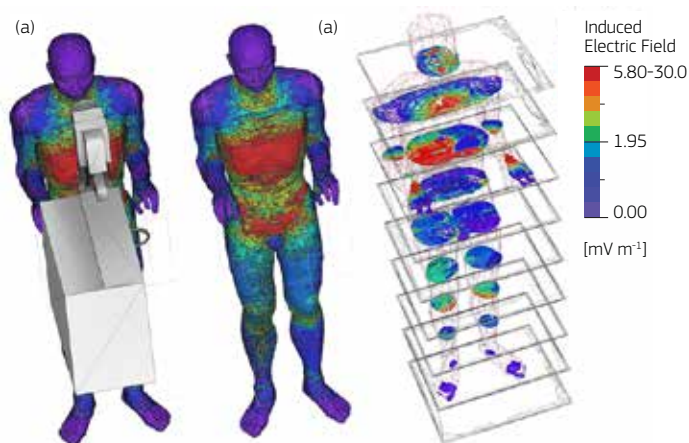
## 7.10 Further information

Computer modelling based on the measurement results around all three welding machines confirm that the induced electric fields were in compliance with the ELVs.

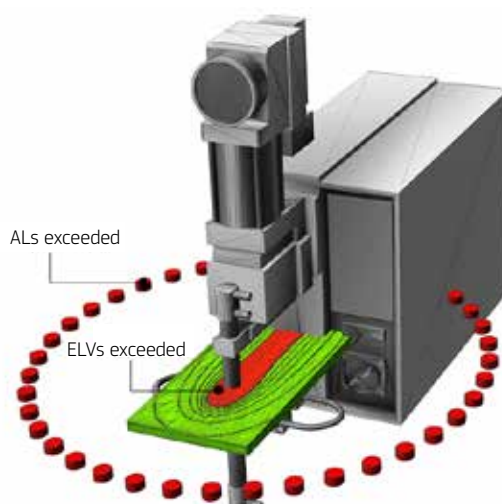
### 7.10.1 Bench-top spot welder

For the bench-top spot welder it was found that the exposure of the operator would be less than 1 % of the ELV (Figure 7.11). The ELV could only be exceeded if the body was located within the gap between the electrodes and the welder housing, or less than a centimetre from the electrodes themselves whilst the unit was in operation (Figure 7.12).

**Figure 7.11 — Distribution of the induced electric field in the human model with the trunk 20 cm away from the electrodes with the hands at a distance of approximately 8 cm. The figure also shows the spatial distribution of the maximum internal electric fields induced in the operator from exposure to the spot welder (a) on the surface of the body and (b) in various horizontal slices within the body**



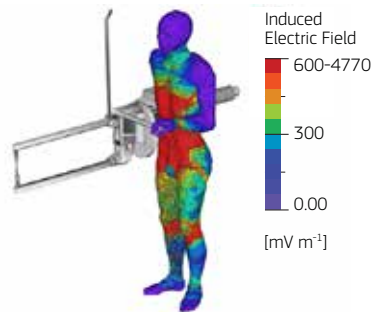
**Figure 7.12 — Contours around the bench-top spot welder showing regions in which the health effects ELV could be exceeded (red area). Also shown are regions where the health effects ELV is not exceeded (green area and beyond) and area in which the low action level could be exceeded (red circles)**



### 7.10.2 Portable suspended spot welder

For the portable suspended spot welder it was found that the ALs were not exceeded at the operator position. However, the distribution of the induced electric field is shown in Figure 7.13.

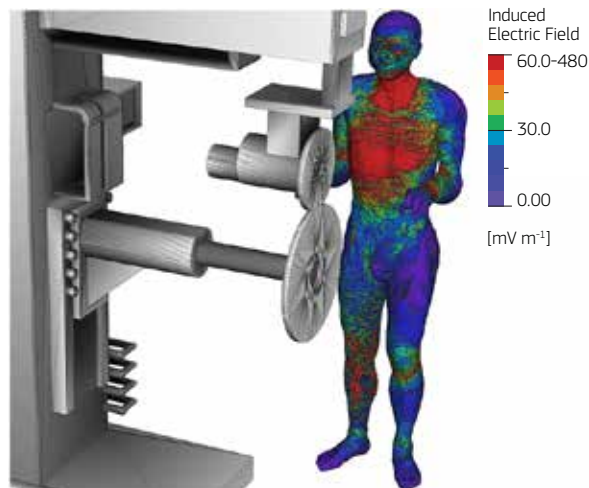
**Figure 7.13 — Spatial distribution of the maximum induced electric fields in a human model when exposed to the portable suspended spot welder**



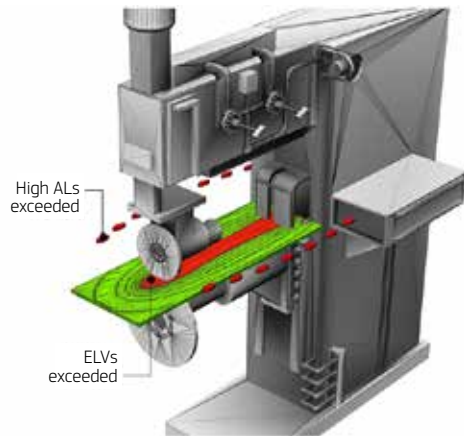
### 7.10.3 Seam welder

The low AL was exceeded at the operator position. However computer modelling shows that the exposure at the operator position is less than 50 % of the ELV. The distribution of the induced electric field is shown in Figure 7.14. It was found that the ELVs could only be exceeded if the body was located within the gap between the electrodes and the welder housing, or less than 5 cm from the wheel electrodes themselves whilst the unit was in operation. This region is shown in red in Figure 7.15.

**Figure 7.14 — Spatial distribution of the maximum internal electric fields induced in the human model from exposure to the seam welder**



**Figure 7.15 — Contours around the seam welder showing regions in which the health effects ELV could be exceeded (red area). Also shown are regions where the health effects ELV is not exceeded (green area and beyond) and area in which the high action level could be exceeded (red dashes)**



## 8. METALLURGICAL MANUFACTURING

The sources of EMF in this case study include the following:

- induction furnaces,
- arc furnaces,
- a carbon and sulphur analyser incorporating a small furnace.

### 8.1 Workplace

The sources of EMF were in use in a number of different workplaces at the factory, which produced speciality metals and alloys for a range of industries. The workplaces of interest were as follows:

- a small volume alloy production facility,
- a ferro-titanium production facility,
- a large electrical melting facility,
- an arc furnace facility,
- an analytical services laboratory.

### 8.2 Nature of the work

Metals and alloys were manufactured from raw materials in several areas around the factory, and the company also carried out analytical testing in a laboratory.

The majority of the work that was the subject of this case study involved loading furnaces manually and, depending on the equipment, this often took place while it was operating.

Any maintenance and repair work on the equipment took place only when it was switched off, due to other risks such as electric shock, burns, impacts from moving machinery, and so on.

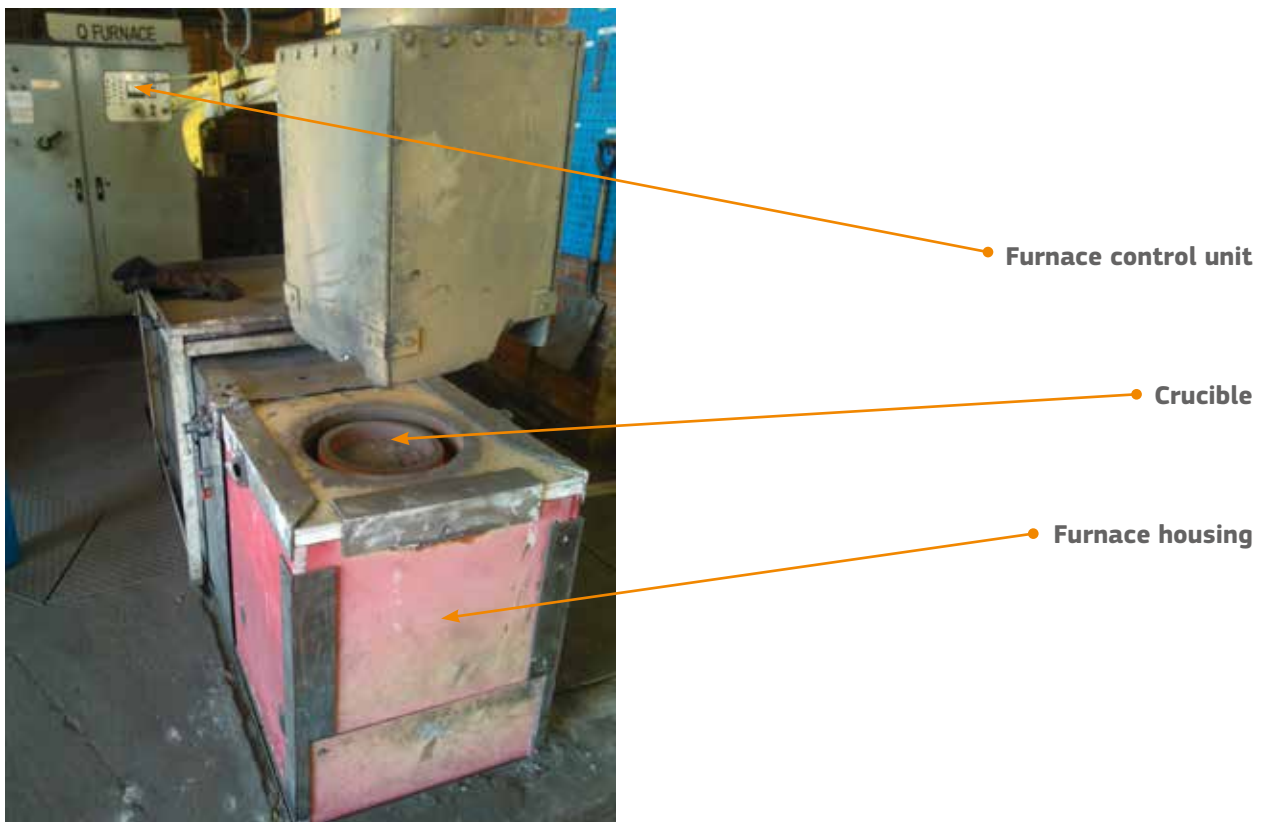
### 8.3 Information on the equipment giving rise to EMF and how it is used

#### 8.3.1 Small volume alloy production facility

This facility produced alloys in a small induction furnace (approximately 30 cm in diameter). The induction furnace operated at frequencies between 2.4 and 2.6 kHz and at powers of between 60 and 160 kW. The furnace is shown in Figure 8.1 and the method of operation is described below: a crucible containing up to 45 kg of the raw material was loaded into the furnace;

- the power is set to 60 kW by the operator and the furnace was switched on, operating at a frequency of 2.42 kHz;
- the power increases automatically to 160 kW over a period of approximately 25 minutes;
- the frequency also increases to 2.6 kHz during this time;
- after approximately 25 minutes, the operator reduces the power to 80 kW;
- after a further five minutes, the operator switches off the furnace and removes the crucible.

**Figure 8.1 — Induction furnace in small volume alloy production facility**



### 8.3.2 Ferro-titanium production facility

There were two 1.5 tonne capacity induction furnaces in this facility, powered by a single variable inductive power (VIP) control unit. The furnaces operated at frequencies between 217 and 232 Hz and at a power of 600 kW. The crucibles were loaded manually, usually while the furnaces were operating.

### 8.3.3 Large electrical melting facility

There were 10 induction furnaces in this facility, each with a capacity of 1.5 tonne, and each operating at a frequency of 50 Hz. The induction coils were an integral part of the crucibles, so that they could apply power and keep the metal molten when it was poured.

The crucibles were set into a raised platform with their tops level with the platform, and the operators typically loaded the crucibles by hand from the platform during the melt process. At the end of the melt process, the crucibles were tilted and the molten metal was poured.

The furnaces operated at a range of powers between 70 and 1 300 kW. The power applied to the furnaces varied throughout the melt process, reducing towards the end, as a lower power was required to keep the metal in molten form once it had been fully melted.

Power to the furnaces was delivered from transformers located in cellars beneath the furnaces. The transformers and busbars were located in cages and access was restricted by means of a castell key system. The VIP control units were located in control rooms on the furnace platform.

### 8.3.4 Arc furnace facility

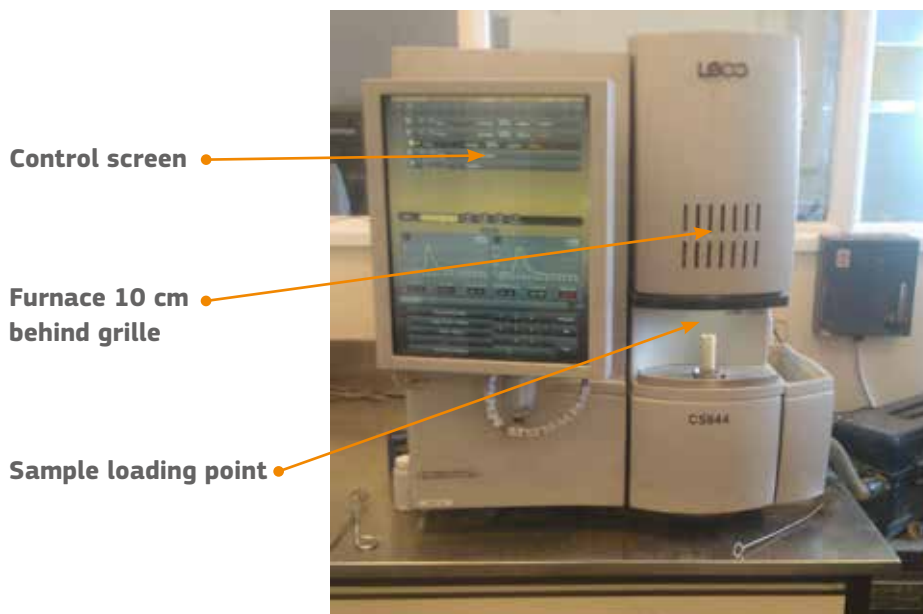
There were two arc furnaces in this facility, producing nickel boron and chromium boron, each operating at a frequency of 50 Hz. The furnaces were continuous batch furnaces, producing around 1 tonne of product per batch. These furnaces were loaded by hand and operated from the control rooms.

The furnaces operated at a power of between 500 and 1 000 kW. The transformers and busbars delivering power to the furnaces were located in cages, and access was restricted by means of a castell key system.

### 8.3.5 Analytical services laboratory

A bench-top carbon and sulphur analyser was used in this laboratory. The analyser incorporated a small 2.2 kW furnace operating at a frequency of 18 MHz. Samples loaded into the analyser by the operator were raised into the centre of the furnace coil, which was located within the analyser, approximately 10 cm inside the casing. The furnace was then powered for around one minute while the analysis took place. The sample was then lowered out of the furnace and retrieved by the operator. The entire process, from loading the sample to retrieving it, was performed automatically, and the operator did not need to stand close to the analyser while it was operating. The analyser is shown in Figure 8.2.

**Figure 8.2 — Carbon and sulphur analyser in analytical services laboratory**



## 8.4 Approach to assessment of exposure

Measurements of exposures were made by an expert consultant using specialised instrumentation. Due to the size of the site and the numerous working areas in which EMF may be encountered, an initial survey was carried out in order to identify any areas where the action levels (ALs) may be exceeded. These areas were then revisited and further, more detailed, measurements were made so that an action plan could be prepared. All measurements were made in locations accessible to workers while the equipment was operating.

The measurements focused on the magnetic fields generated by the equipment, as these were likely to have the greatest contribution to the exposure of workers.

When assessing the exposure of workers at particular risk, comparison was made with the reference levels given in the Council Recommendation (1999/519/EC) (see Appendix E of Volume 1 of the guide).

### 8.4.1 Small volume alloy production facility

Measurements were made at various locations around the facility throughout the melt process. The measurement locations included:

- close to the furnace,
- close to the control unit,
- close to cables feeding the control unit,
- close to cables running from the control unit to the furnace,
- in the operator's cabin.

### 8.4.2 Ferro-titanium production facility

Measurements were made at various locations around the facility throughout the melt process. The measurement locations included:

- close to the furnaces,
- close to the VIP control unit,
- close to cables feeding the control unit,
- close to cables running from the control unit to the furnace,
- at the operator's desk.

### 8.4.3 Large electric melting facility

Measurements were made at numerous locations around the facility while the furnaces were operating. The measurement locations included:

- operators' positions when loading furnaces from the platform,
- operators' positions when operating crucible tilt mechanisms,
- close to the crucible during tilt,

- control rooms,
- close to the VIP control units,
- close to cables feeding the control units,
- close to cables running from the control units to the furnaces,
- outside the cages in the transformer cellars,
- under busbars at closest points of access.

#### **8.4.4 Arc furnace facility**

Measurements were made at numerous locations around the facility while the furnaces were operating. The measurement locations included:

- operators' positions when loading furnaces,
- control rooms,
- close to control units,
- closest points of access around the bases of the furnaces,
- under busbars at closest points of access,
- around the transformer cages,
- walkways around the furnaces.

#### **8.4.5 Analytical services laboratory**

Measurements were made around the analyser while the furnace was operating. Particular attention was given to the area around the furnace and the area where the operator was standing while the analysis was taking place.

### **8.5 Results from exposure assessment**

#### **8.5.1 Initial exposure assessment**

The results of the exposure measurements were compared with the high and low ALs and the reference levels given in the Council Recommendation (1999/519/EC). If the results were found to exceed the ALs in any working area, a further measurement was made in order to determine the distance at which the magnetic flux density was equal to 100 % of the AL, so that a decision could be made on whether to carry out a more detailed assessment based on the likelihood of occupancy of the area in which the AL was exceeded. The significant findings of the initial exposure assessment are summarised in Table 8.1.



**Table 8.1 — Summary of significant findings of initial exposure assessment**

Work area	Equipment	Areas of greatest exposure and location of boundary of action level (where relevant)	Exposure fraction (percent)		
			Low action level	High action level	1999/519/EC reference level
Small volume alloy production facility	Induction furnace (2.42 to 2.6 kHz)	50 cm from edge of furnace casing	190 % <sup>1</sup>	190 % <sup>1</sup>	3 500 % <sup>2</sup>
		80 cm from edge of furnace casing	100 % <sup>1</sup>	100 % <sup>1</sup>	1 800 % <sup>2</sup>
Ferro-titanium production facility	Two induction furnaces (217 to 232 Hz)	Torso position when standing close to VIP control unit	7.8 % <sup>3</sup>	6.0 % <sup>4</sup>	360 % <sup>5</sup>
Large electrical melting facility	10 induction furnaces (50 Hz)	30 cm from cables to crucible during tilt	40 % <sup>3</sup>	6.7 % <sup>6</sup>	400 % <sup>7</sup>
Arc furnace facility	Two arc furnaces (50 Hz)	Torso position when standing at point of closest access to base of furnace	70 % <sup>3</sup>	12 % <sup>6</sup>	700 % <sup>7</sup>
Analytical services laboratory	Carbon & sulphur analyser incorporating an RF furnace (18 MHz)	20 cm from surface of analyser casing	110 % <sup>8</sup>		230 % <sup>9</sup>
		22 cm from surface of analyser casing	100 % <sup>8</sup>		220 % <sup>9</sup>

<sup>1</sup> Magnetic flux density high and low action levels for frequency of 2.6 kHz: 115 µT

<sup>2</sup> Council Recommendation (1999/519/EC) reference level for frequency of 2.6 kHz: 6.25 µT

<sup>3</sup> Magnetic flux density low action level for frequencies in the range 25 to 300 Hz: 1 000 µT

<sup>4</sup> Magnetic flux density high action level for frequency of 230 Hz: 1 300 µT

<sup>5</sup> Council Recommendation (1999/519/EC) reference level for frequency of 230 Hz: 21.7 µT

<sup>6</sup> Magnetic flux density high action level for frequency of 50 Hz: 6000 mT

<sup>7</sup> Council Recommendation (1999/519/EC) reference level for frequency of 50 Hz: 100 µT

<sup>8</sup> Magnetic flux density action level for frequencies in the range 10 to 400 MHz: 0.2 µT

<sup>9</sup> Council Recommendation (1999/519/EC) reference level for frequencies in the range 10 to 400 MHz: 0.092 µT

NB: The uncertainty in the measurements was estimated to be ±10 % and in accordance with the 'shared risk' approach (see Appendix D5 of Volume 1 of the Guide) the results were taken as direct percentages of the ALs.

The results of the initial exposure assessment provided the company with the following information:

- the high and low ALs were exceeded up to a distance of 80 cm from the induction furnace in the small volume alloy production facility and this area was easily accessible to workers for the duration of the melt process;
- the AL was exceeded up to a distance of 22 cm from the carbon and sulphur analyser in the analytical services laboratory and workers did not place any part of their bodies in this area while the furnace was operating;
- the reference levels given in the Council Recommendation (1999/519/EC) were exceeded in accessible locations in all of the work areas assessed.

In the example of the carbon and sulphur analyser, the area in which the AL was exceeded was small, and so the way in which the analyser operated ensured that workers were not likely to be exposed to electric and magnetic fields in excess of the ALs.

Based on the findings of the initial exposure assessment, the consultant carried out a more detailed assessment of the induction furnace in the small volume alloy production facility.

## 8.5.2 Detailed exposure assessment of induction furnace in small volume alloy production facility

The consultant performed an exposure assessment, which included an observation of how the furnace was operated, so that a practical solution to the problem could be delivered.

Several measurements of magnetic flux density were made at a variety of locations around the furnace. The results of these measurements allowed contours of the ALs and the reference levels given in the Council Recommendation (1999/519/EC) to be established. Marks were also made on the floor to indicate the extent of the area in which the ALs were exceeded (Figure 8.3). The significant findings of the detailed exposure assessment are summarised in Table 8.2. A scale drawing of the furnace, showing the contours of the ALs and the reference levels given in the Council Recommendation (1999/519/EC), is shown in Figure 8.4.

**Table 8.2 — Summary of significant findings of detailed exposure assessment of induction furnace in small volume alloy production facility**

Measurement location	Exposure fraction (percent)		
	High and low action levels <sup>1</sup>	Limb action level <sup>2</sup>	Reference levels given in Council Recommendation (1999/519/EC) <sup>3</sup>
45 cm from edge of furnace casing (distance to limb action level)	300 %	100 %	5 500 %
80 cm from edge of furnace casing (distance to limb action level)	100 %	33 %	1 800 %
300 cm from edge of furnace casing (distance to 1999/519/EC reference level)	5.4 %	1.8 %	100 %
Torso position when standing at control unit	3.5 %	1.2 %	64 %
450 cm from edge of furnace casing (torso position when standing in operator's cabin)	2.0 %	0.67 %	37 %

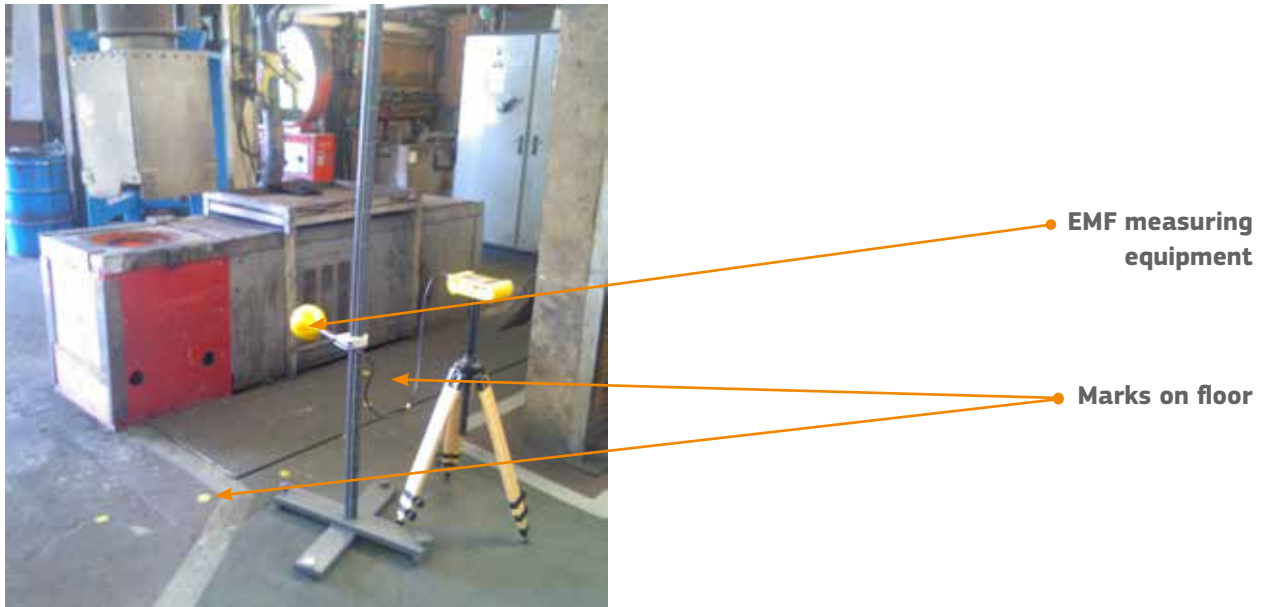
<sup>1</sup> Magnetic flux density high and low action levels for frequency of 2.6 kHz: 115 µT

<sup>2</sup> Magnetic flux density limb action level for frequency of 2.6 kHz: 346 µT

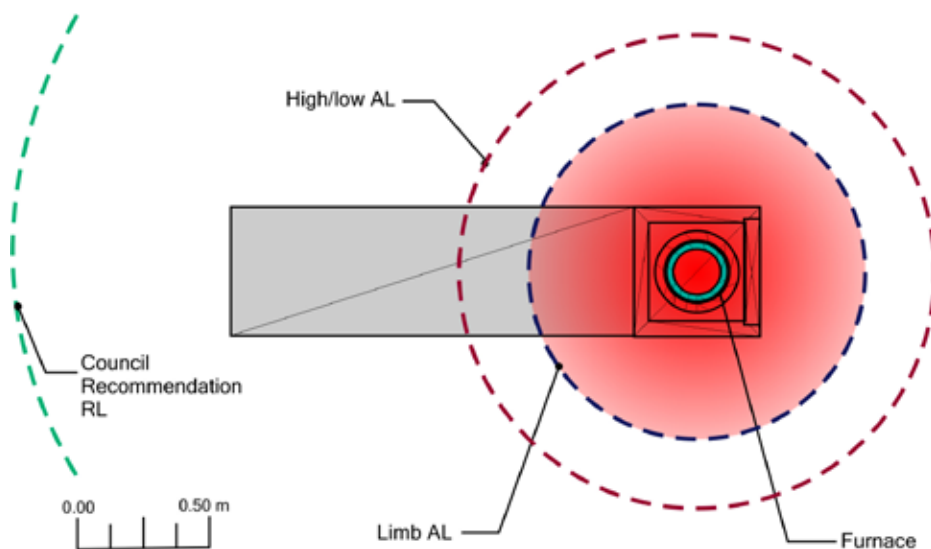
<sup>3</sup> Council Recommendation (1999/519/EC) reference level for frequency of 2.6 kHz: 6.25 µT

*NB:* The uncertainty in the measurements was estimated to be ±10 % and in accordance with the 'shared risk' approach (see Appendix D5 of Volume 1 of the Guide) the results were taken as direct percentages of the ALs.

**Figure 8.3 — Marks on the floor indicating the extent of the area in which the high and low action levels were exceeded**



**Figure 8.4 — Plan view showing the contours within which the action levels and reference levels given in the Council Recommendation (1999/519/EC) could be exceeded around the induction furnace in the small volume alloy production facility**



The contours shown in Figure 8.4 are in the form of circles centred on the middle of the furnace. It was observed that the operator did not need to enter the area within the high and low AL contour when the furnace was operating, as all tasks involving access to this area (loading the crucible into the furnace before the melt process and unloading it after completion of the melt process) were performed with the furnace switched off (Figure 8.5). This indicated that prevention of access to the area was the best course of action in order to restrict exposure to the strong magnetic fields. However, it was noted that installing barriers around the furnace was not practicable as this would cause an obstruction and increase the risk of more serious accidents occurring when manipulating the crucibles.

**Figure 8.5 — Tasks involving close access to the furnace were performed with the furnace switched off**



## 8.6 Risk assessment

Based on the exposure assessment performed by the consultant, the company carried out an EMF specific risk assessment of the site in relation to EMF. This was consistent with the methodology suggested by OiRA (the EU-OSHA's online interactive risk assessment platform). The risk assessment concluded that:

- workers at particular risk may encounter a hazard in any of the work areas at the site,
- workers, including those at particular risk, had unrestricted access to an area in which the ALs were exceeded in the small volume alloy production facility.

The company developed an action plan from the risk assessment and this was documented.

An example of an EMF specific risk assessment for the site is shown in Table 8.3.

**Table 8.3 — EMF specific risk assessment for metallurgical manufacturing site**

Hazards	Existing preventive and precautionary measures	People at risk	Severity			Likelihood			Risk evaluation	New preventive and precautionary actions
			Minor	Serious	Fatal	Improbable	Possible	Probable		
Magnetic field direct effects	None	Workers in small volume alloy production facility	✓					✓	Medium	Prevent access to area in which action levels are exceeded  Display appropriate warning notices in work area in which action levels are exceeded
		Workers in other areas assessed	✓			✓			Low	Provide specific warnings in site safety training for workers
		Visitors	✓				✓		Low	Display appropriate warning notices for persons fitted with medical implants at points of access to other working areas
		Workers at particular risk (including pregnant workers)		✓			✓		Medium	Provide warnings in site safety information for visitors and contractors
Magnetic field indirect effects (interference with medical implants)	None	Workers at particular risk		✓			✓		Medium	See above

## 8.7 Precautions already in place

Access to the transformers and busbars associated with the equipment had been restricted because of the electric shock risk, and this would have also provided some restriction of access to potentially strong magnetic fields, but there were no precautions in place specifically related to EMF exposure before the consultant carried out the exposure assessment.

One notable observation was that the ALs were not exceeded in any normally accessible locations around the large production furnaces or their control units, despite the significantly greater powers involved. This was likely to be as a result of the physical size of the equipment, which meant that access to potentially strong magnetic fields was not possible. The areas in which the ALs could be exceeded were found to be around smaller equipment, simply because closer access was possible.

## 8.8 Additional precautions as a result of the assessment

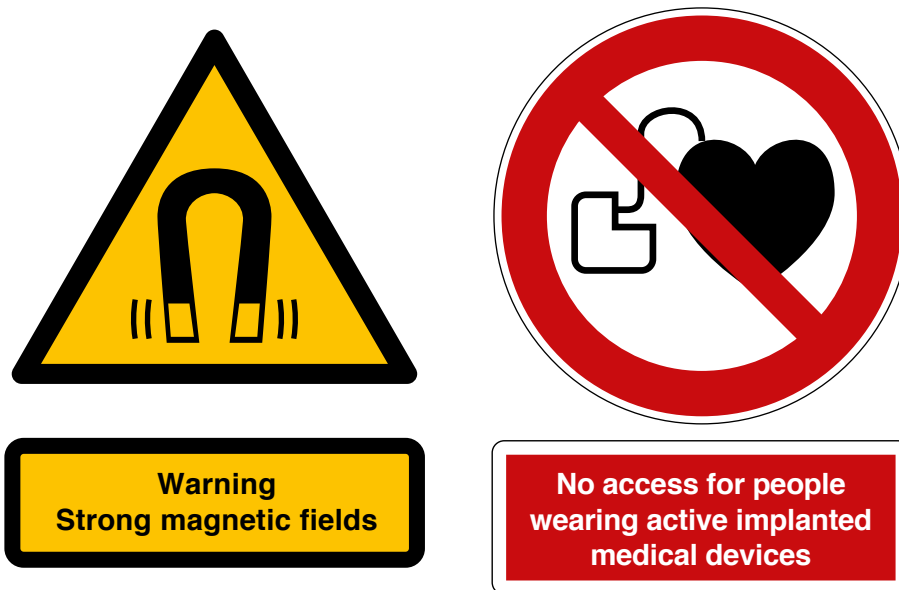
Based on the results of the exposure assessment, the company was able to introduce protection and prevention measures to ensure that workers, including those at particular risk, would not be exposed to EMF at levels that could cause harm. Some additional precautions were put in place immediately after the initial exposure assessment. These measures included:

- persons fitted with medical implants were prevented from entering the work areas;
- the company's health and safety induction film was updated to include a warning of the presence of strong magnetic fields and a warning to persons fitted with medical implants;
- warning notices, incorporating the 'magnetic field' and 'no medical implants' pictograms, along with appropriate wording (Figure 8.6), were displayed at the points of access to the relevant working areas.

Further protection and prevention measures were put in place following the more detailed exposure assessment:

- markings were painted on the floor around the induction furnace in the small volume alloy production facility to indicate the area in which the ALs were exceeded (Figure 8.7), and workers were instructed to not enter the area when the furnace was operating;
- warning notices, incorporating the 'strong magnetic field' and prohibition pictograms and appropriate wording (Figure 8.7), were displayed close to the induction furnace.

**Figure 8.6 — Example of a warning notice displayed at points of access to work areas**



**Figure 8.7 — Painted floor and associated warning notice to indicate the area in which the action levels could be exceeded**



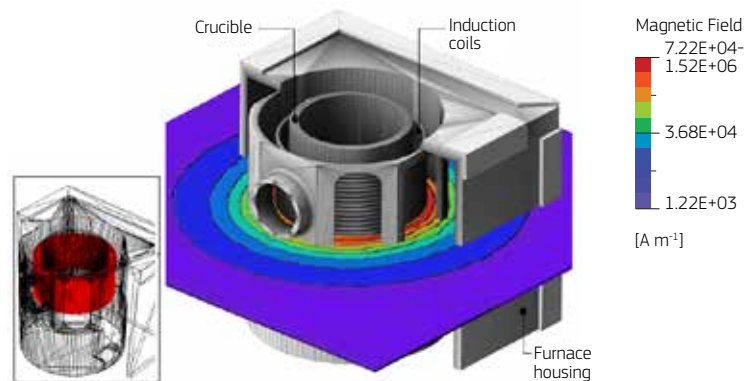
## 8.9 Further information

For completeness, the company consulted an expert to carry out computer modelling of the potential exposure, in terms of the ELVs, of a worker standing within the hatched area while the small volume alloy production furnace was operating.

The computer modelling was performed to assess the internal electric fields induced in the body of an operator in close proximity to the operating furnace. The parameters of the modelling were set at particular values such that the model produced similar magnetic field strength values to those obtained in the measurement phase of the exposure assessment.

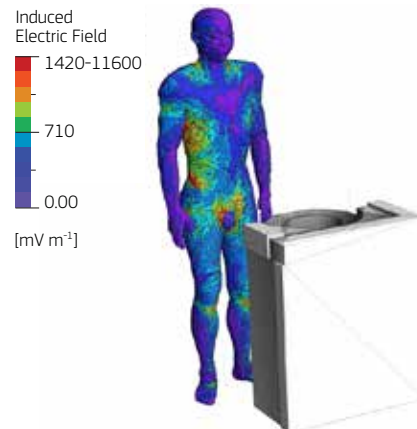
The spatial distribution of the magnetic field in the x-y plane around the induction furnace generated by the model is shown in Figure 8.8. These calculated field values agreed well with the measured values obtained during the exposure assessment and further demonstrated that, whilst the magnetic field strengths are relatively high when close to the furnace induction coil, these values drop off very quickly with distance.

**Figure 8.8 — Spatial distribution of the magnetic field in the  $x$ - $y$  plane around a cutaway image of the induction furnace, generated by the model. The induction coil is shown in red (inset)**



Calculations of the internal electric fields induced in the body were performed for a worker standing 65 cm from the centre of the induction furnace. The distribution of induced electric field in a human model is shown in Figure 8.9. The highest electric field value calculated in the body for this exposure situation was  $916\ mV\ m^{-1}$  (in bone tissue). This represented 83 % of the health effects ELV at 2.43 kHz.

**Figure 8.9 — Spatial distribution of the maximum internal electric fields induced in a human model from exposure to the induction furnace**



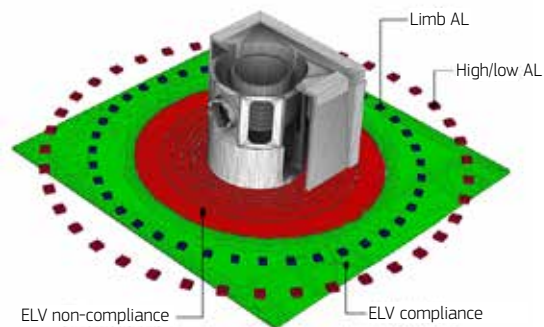


A region in which the health effects ELV could be exceeded from exposure to the induction furnace could be defined by carrying out exposure simulations utilising the human model at various distances from the furnace.

It was found that the ELV would only be exceeded if the body was located within a radius of approximately 60 cm of the centre of the furnace while in operation. This region is approximated in red in Figure 8.10. Also shown are the areas in which the ALs could be exceeded (Figure 8.4).

Given that the furnace was mounted within a housing that was approximately 63 cm x 63 cm (i.e., extending to a distance of 31.5 cm from the centre of the furnace), a worker would have to stand with their body so close to the furnace housing for the ELVs to be exceeded that it was considered an unlikely exposure scenario. This gave the company confidence that the painted floor was an adequate prevention measure.

**Figure 8.10 — Contours around the induction furnace showing regions in which the health effects ELV could be exceeded (red area). Also shown are regions in which the health effects ELV is not exceeded (green area and beyond), and regions in which the action levels could be exceeded (blue and red squares)**



## 9. RADIOFREQUENCY (RF) PLASMA DEVICES

RF plasma devices are typically used in semiconductor device fabrication, the manufacture of integrated circuits. They are also used in other industries for cleaning optical components, spectroscopic applications and research. This case study relates to RF plasma devices used in the wafer fabrication process within a clean room environment. The employer was concerned about the potential hazard posed to a worker fitted with a cardiac pacemaker, who was preparing to return to the workplace. The manufacturer of the pacemaker provided the employer with details of safe limits of exposure of the pacemaker to electromagnetic fields.

### 9.1 Nature of the work

The pacemaker wearer's role typically involves loading wafers into the RF plasma devices and operating the devices (Figure 9.1).

**Figure 9.1 — Wafer loading area**



**Figure 9.2 — Reaction chambers in the service area**



### 9.2 Information on the equipment giving rise to EMF

The RF plasma devices in this workplace typically consist of an RF source and an evacuated reaction chamber (Figure 9.2). Some devices on-site incorporate multiple RF sources and/or multiple reaction chambers. The RF field generated is used to establish and maintain a plasma discharge, which is used to carry out processes such as etching, deposition and stripping of the wafer inside the chamber. The RF frequencies generated can range from a few hundred kHz up to a few GHz. Common frequencies used are 400 kHz, 13.56 MHz and 2.45 GHz.

With this type of device, the RF field will usually be shielded by the equipment housing and metallic reaction chamber. RF leakage is possible where there are gaps in the equipment housing, such as misaligned or incorrectly fitted panels, missing screws, faulty cable connectors and damage to flexible waveguides. Any gaps in the reaction chamber or waveguides are likely to be observed by a loss in vacuum. Some of the chambers incorporate viewing windows with protective (Faraday) screens; missing or damaged screens may result in RF leakage.

Some of the devices also incorporate strong magnets, resulting in the production of static magnetic fields.

### 9.3 How the application is used

The pacemaker wearer will typically remain in the production area of the clean room, where the equipment is operated, and the wafers are loaded. The reaction chambers and RF generators associated with each piece of equipment are located in the service area. This worker may enter the service area but will not be involved in servicing or maintaining the equipment.

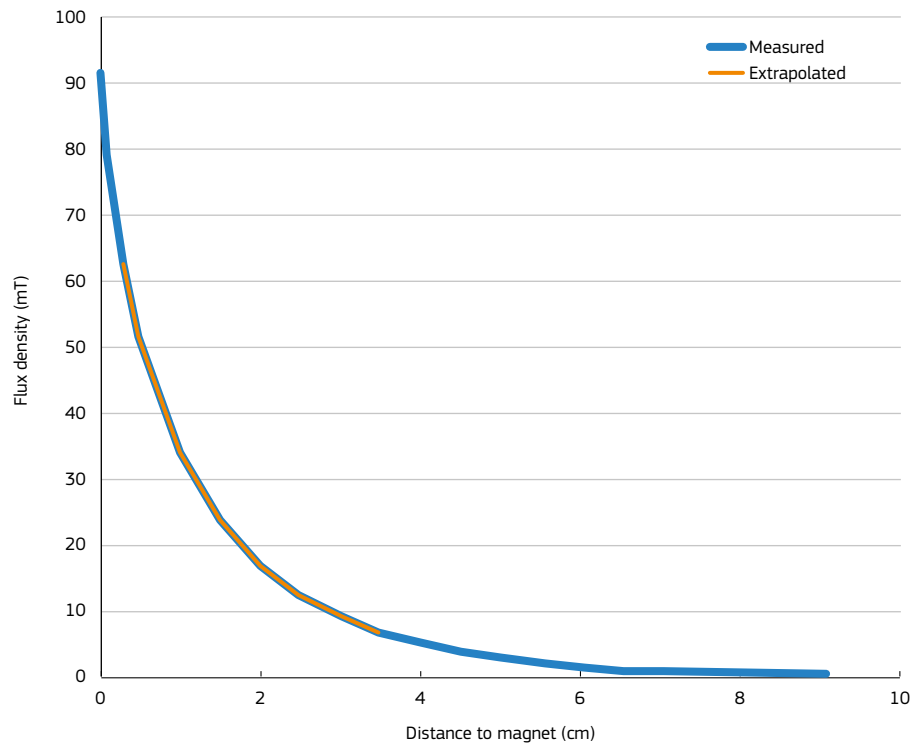
### 9.4 Approach to assessment of exposure

It would be possible to make measurements of electromagnetic fields around this equipment. However, this would require the services of an expert consultant using specialised instrumentation. Multiple measurement devices would be required due to the variety of frequencies used. In addition, for the intermediate frequency fields (e.g. 400 kHz and 13.56 MHz), measurements would need to be made in the 'near field'. The electric and magnetic fields would have to be measured separately. At higher frequencies (2.45 GHz), the measurements will generally be made in the 'far field'. In this situation, the electric and magnetic fields propagate as an electromagnetic wave and so it is more usual to measure just the electric field. The magnetic field can be inferred as the two are related.

As a first step to assessing exposure, the employer contacted the manufacturers of the RF plasma devices to ask for information on the potential for leakage of RF fields from the equipment, and the distance over which this might present a hazard.

One of the manufacturers provided a graph (Figure 9.3) to illustrate how the level of static magnetic field decreases with distance from the strong magnets installed in the devices, and informed the employer that at a distance of 10 cm from the magnets the flux density will decrease below 0.5 mT.

**Figure 9.3 — Graph showing the magnetic flux density decreasing with distance**



The pacemaker manufacturer provided safe limits for various sources of electromagnetic interference (Table 9.1). The employer noted that the value for static magnetic fields was quoted in gauss and would need to be converted to millitesla as per the EMF Directive.

**Table 9.1 — Safe limits provided by the pacemaker manufacturer (limits specific to the particular pacemaker worn by the worker)**

EMI Source	Electromagnetic Field Intensity Limit (rms)
Power Frequency (50/60 Hz)	10 000 V/m (6 000 V/m; outside nominal)
High Frequency (150 kHz & up)	141 V/m
Static Magnetic Fields (DC)	10 gauss
Modulated Magnetic Fields	80 A/m up to 10 kHz and 1 A/m for greater than 10 kHz

The employer was unable to obtain any information from the manufacturers regarding RF fields, and so decided to appoint a consultant to carry out some measurements around a selection of the RF plasma devices.

## 9.5 Results from exposure assessment

The employer converted the relevant limits supplied by the pacemaker manufacturer (Table 9.1) into the same units used in the EMF Directive (Table 9.2). Comparing the measurement results to these limits demonstrates that the pacemaker limits were not exceeded around the RF plasma etcher.

**Table 9.2 — Pacemaker limits (provided by pacemaker manufacturer)**

Frequency	Limit
Electric Fields, 150 kHz and above	141 Vm <sup>-1</sup>
Static magnetic fields (DC)	1 mT
Magnetic fields above 10 kHz	1.25 µT

The measurement results obtained are detailed in the tables below. Table 9.3 shows the results of measurements made around an RF plasma etcher operating at 400 kHz. Measurements were made around the whole device, however the maximum levels of electric and magnetic fields were found around the joints in the casing surrounding the RF generator. The measurement results show that the action levels (ALs) in the EMF Directive were not exceeded.

**Table 9.3 — Results of measurements around RF plasma etcher**

Position	Frequency	Magnetic flux density (µT)	Action level (µT)	Electric field strength (Vm <sup>-1</sup> )	Action level (Vm <sup>-1</sup> )
RF generator cabinet	400 kHz	0.05	5	0.06	610

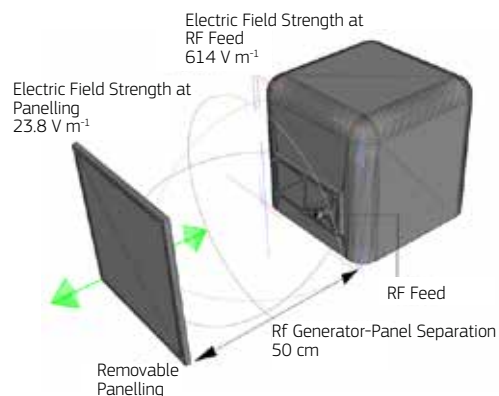
*NB:* The uncertainty in the measurements was estimated to be +2.7 dB and in accordance with the 'shared risk' approach (see Appendix D5 of Volume 1 of the Guide) the results were compared directly with the ALs.

Table 9.4 shows the results of measurements made around a physical vapour deposition (PVD) unit operating at 13.56 MHz. The measurement results show that the ALs in the EMF Directive, as well as the pacemaker limits in Table 9.2, were exceeded close to the RF feed into the chamber. The latter two measurement positions are shown in Figure 9.4.

**Table 9.4 — Results of measurements around PVD unit**

Position	Generator frequency	Magnetic flux density ( $\mu\text{T}$ )	Action level ( $\mu\text{T}$ )	Electric field strength ( $\text{V m}^{-1}$ )	Action level ( $\text{V m}^{-1}$ )
Top surface of chamber	13.56 MHz	0.04	0.2	10	61
Below the chamber, close to the RF feed into the chamber	13.56 MHz	2	0.2	614	61
Position of removable panelling, positioned 0.5 m from the RF feed.	13.56 MHz	0.08	0.2	24	61

*NB:* The uncertainty in the measurements was estimated to be  $\pm 2.7$  dB and in accordance with the 'shared risk' approach (see Appendix D5 of Volume 1 of the Guide) the results were compared directly with the ALs.

**Figure 9.4 — Position of measurements taken close to the RF feed into the PVD unit**

## 9.6 Risk assessment

With regard to the static magnetic fields around the magnets, it was found that the AL of 0.5 mT, for exposure to active implanted medical devices, could be exceeded within 10 cm of the magnets. However, the employer had been provided with a less restrictive limit of 1 mT (Table 9.2) by the pacemaker manufacturer, which was applicable to the pacemaker in question. Therefore the employer used this limit in the risk assessment. Based on the graph supplied by the equipment manufacturer (Figure 9.3), the pacemaker limit of 1 mT could be exceeded at a distance of less than 10 cm from the magnets (estimated to be about 6 cm).

With regard to the RF electromagnetic fields, it was found that the limits specified by the pacemaker manufacturer, as well as the ALs could be exceeded close to the RF feed into the chamber of the PVD unit. At 0.5 m from the RF feed, the levels dropped below the pacemaker limits and the ALs.

For both static magnetic and RF fields, the field level dropped below the pacemaker limits and ALs over a short distance.

Based on this information, the employer carried out an EMF specific risk assessment (Table 9.5) to determine the risks both to the pacemaker wearer as well as other workers, using the methodology suggested by OIRA (the EU-OSHA's online interactive risk assessment platform).

As a result of this risk assessment, the employer decided that no change to the pacemaker wearer's duties would be necessary; the individual was not involved with equipment maintenance, and so would have no cause to be in areas (very close to the equipment) in which the pacemaker limits could be exceeded. It was decided that access to the service area would not need to be prohibited, as the high fields are very localised. However, the risk assessment does indicate that consideration should be given to other workers (e.g. service engineers) and contractors who may be fitted with active implanted medical devices.

## 9.7 Precautions already in place

The employer inspected the equipment and reviewed the company's procedures and found that it already had the following precautions in place:

- there was guarding in place around RF feeds into chambers, to prevent access to these areas (for the measurement of the PVD unit, the guarding was removed);
- the company ensures that any equipment purchased is well designed. For example, viewing windows are appropriately shielded to restrict RF field exposure.

**Table 9.5 — EMF specific risk assessment for RF plasma devices**

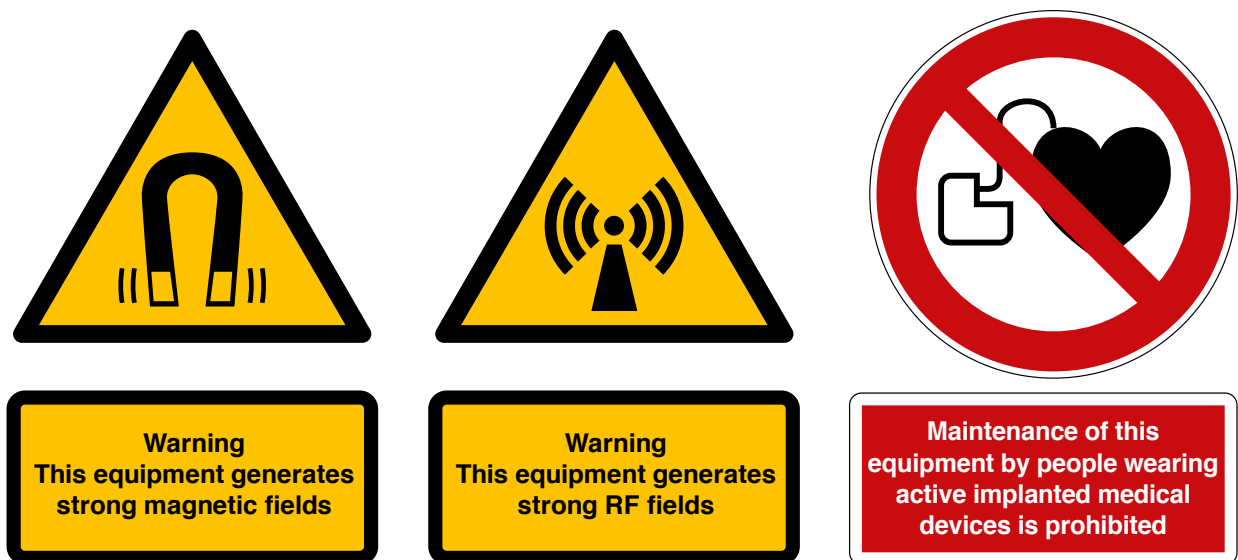
Hazards	Existing preventive and precautionary measures	People at risk	Severity			Likelihood			Risk evaluation	New preventive and precautionary actions
			Minor	Serious	Fatal	Improbable	Possible	Probable		
EMF direct effects:  The action level could be exceeded close to the RF feed in the service area	Panel fitted to the PVD unit, which prevents access to the area in which the action level is exceeded	Operators  Service engineers	✓					✓	Low	Information and training to be provided to service engineers and operators  Appropriate warning notices to be displayed on equipment
EMF indirect effects (effect on active implanted medical devices):  The pacemaker limits could be exceeded close to the static magnets and close to the RF feed in the service area	Panel fitted to the PVD unit, which prevents access to the area in which the pacemaker limits are exceeded  Fields in excess of the pacemaker limits around the static magnets are very localised	Workers at particular risk	✓			✓			Low	Information regarding this hazard to be given to all workers  Warnings to be provided in site safety information  Appropriate warning and prohibition notices to be displayed on the equipment

## 9.8 Additional precautions as a result of the assessment

As a result of the risk assessment, the employer decided to implement additional precautionary measures, including:

- posting notices warning of strong magnetic fields/strong RF fields (as appropriate) as well as prohibition notices for active implanted medical device (AIMD) wearers, on equipment containing strong magnets and on removable panels accessing potentially high levels of RF fields (Figure 9.5);

**Figure 9.5 — Examples of warning notices for strong magnetic and strong RF fields and an illustration of the prohibition symbol for AIMD wearers**



- providing information, including the outcome of the risk assessment, to the pacemaker wearer and the company's occupational health service provider;
- ensuring, through appropriate induction programmes and liaison with contractors that other workers and visitors are aware of the risks;
- ensuring that workers are aware that the equipment must not be operated with panels removed and that any damage to equipment housing, waveguides or shielded windows must be reported to a supervisor.

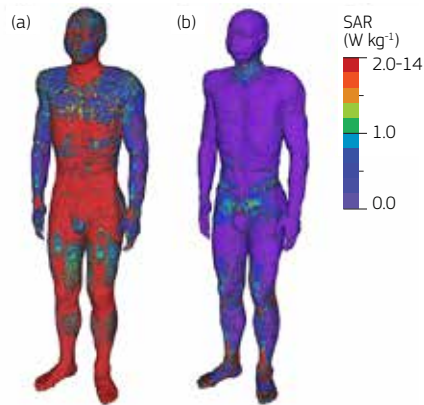


## 9.9 Further information

The measured results were used as a basis for computer modelling the exposure of a worker in relation to the exposure limit values (ELVs) given in the EMF Directive (Figure 9.5). The modelling shows that close to the RF feed, the ELVs could be exceeded; the whole body average SAR was 211 % of the ELV for whole-body heat stress, and the peak localised SAR averaged over a 10 g contiguous mass in the limbs, was 147 % of the ELV for heat stress in the limbs. The ELV for localised heat stress in the head and trunk was not exceeded; the peak localised SAR, averaged over a 10 g contiguous mass in the head and trunk was 89 % of the ELV for localised heat stress in the head and trunk.

At 0.5 m from the RF feed the measured electric field strength was found to be lower than the AL, and so, as expected, the modelling showed that the whole-body and localised SAR values were much less than the ELVs (less than 0.5 %).

**Figure 9.6 — SAR distribution in a worker for (a) around the RF feed and (b) around the removable panelling, 50 cm from the RF generator**



## 10. ROOFTOP ANTENNAS

### 10.1 Workplace

Rooftops of buildings are often used as convenient mounting structures for a variety of telecommunications antennas the operation of which benefit from the increased elevation or improved line of sight. This case study relates to such a building (Figure 10.1), which had recently transferred ownership. The new landlord was keen to fulfil the legal obligation and assess all risks to workers on the rooftop.

**Figure 10.1 — Mobile phone sector antennas and a microwave dish on the roof of the lift house**



### 10.2 Nature of the work

Workers are required to access the rooftop to carry out a variety of building inspection and maintenance tasks. These may include: window cleaners, roofing contractors, air conditioning engineers, insurance inspectors and antenna riggers. The latter groups may have received extensive training in radiofrequency radiation safety and may be equipped with personal exposure alarms, while the former groups are likely to have received no training and accordingly have little knowledge of the issues.

Good practice would be for the operators to adopt a 'safe by position' principal when installing antennas. This means that the antennas are located so that workers at normal roof standing level cannot inadvertently enter an antenna exclusion zone. The antenna exclusion zone is the area near the antenna where the exposure could exceed the reference levels given in the Council Recommendation (1999/519/EC).

An antenna exclusion zone should only be accessible to workers with climbing aids such as ladders or scaffolds. Where workers need to access an exclusion zone then it may be necessary to shut down the antenna. If an antenna exclusion zone must impinge upon the rooftop standing area then the rooftop area should be demarcated.

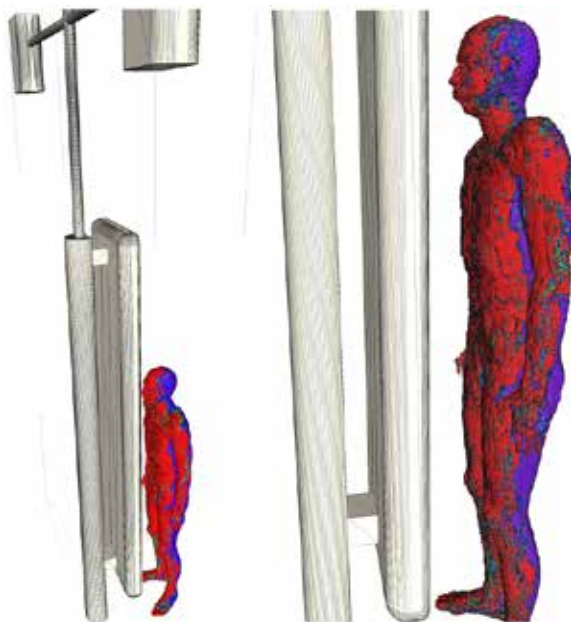
### 10.3 Information on the equipment giving rise to EMF

The antennas mounted on the rooftop were those generally associated with mobile telecommunication systems including mobile phone base stations and a pager system. In addition to sector antennas, the mobile phone base station also included a point-to-point data link. The landlord was aware that different types of antennas present different levels of hazard and broadly speaking that:

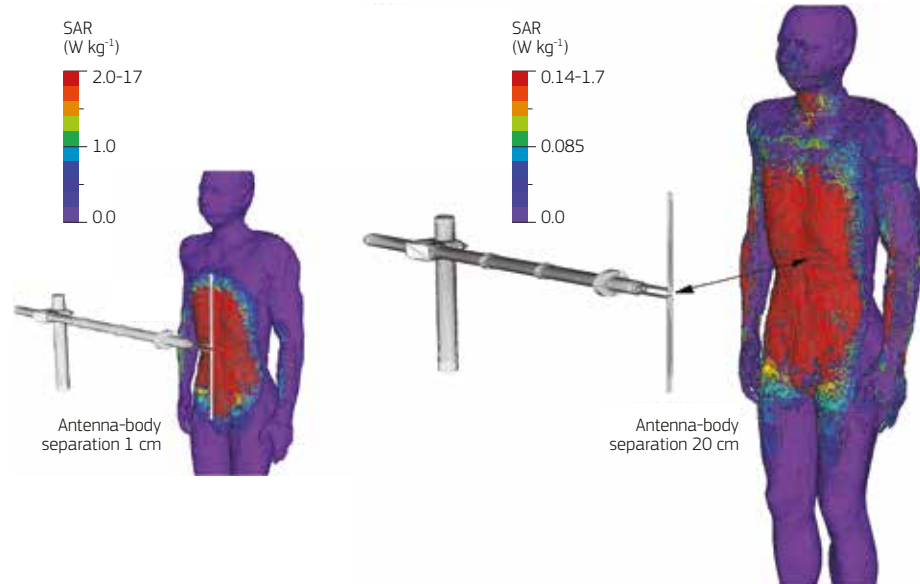
- mobile phone sector antennas (800 — 2 600 MHz) may present a hazard in the forward direction up to a few metres and to a lesser extent to the sides and the rear (Figure 10.2);
- microwave dish antennas (10 — 30 GHz) associated with mobile phone base stations tend not to present a significant hazard;
- dipole and collinear (whip) antennas (80 — 400 MHz) may present a hazard a metre or two around the antenna.

This latter point is illustrated by computer modelling for a half-wave dipole antenna operating at 400 MHz (Figure 10.3). Table 10.1 shows that as the radiated power is increased from 25 W, to 100 W and then to 400 W, the health effects ELVs are exceeded at increasing distances from the antenna.

**Figure 10.2 — Specific energy absorption rate (SAR) distribution in a worker situated next to a transmitting mobile phone sector antenna**



**Figure 10.3 — Specific energy absorption rate (SAR) distribution in the human model from exposure to a 25 W half-wave dipole antenna, 20 cm from the torso. Inset: 1 cm from the torso. In both cases the calculated SAR values are less than the corresponding health effects ELVs**



**Table 10.1 — Computer modelled values of whole-body specific energy absorption rate (WBSAR) and peak localised SAR, averaged over a 10 g contiguous mass (SAR<sub>10g cont</sub>) for a 5 W, 25 W, 100 W and 400 W half-wave dipole antenna. SAR values in excess of the corresponding health effects ELV are written in red font type**

Distance (cm)	Modelled SAR (Wkg <sup>-1</sup> )							
	5 W antenna		25 W antenna		100 W antenna		400 W antenna	
	WBSAR	SAR <sub>10g cont</sub>	WBSAR	SAR <sub>10g cont</sub>	WBSAR	SAR <sub>10g cont</sub>	WBSAR	SAR <sub>10g cont</sub>
0.1	0.0225	1.61	0.113	8.05	0.450	32.2	1.80	129
1	0.0194	1.28	0.0968	6.38	0.387	25.5	1.55	102
2	0.0168	1.04	0.0840	5.18	0.336	20.7	1.34	82.8
4	0.0133	0.715	0.0663	3.58	0.265	14.3	1.06	57.2
6	0.0110	0.525	0.0548	2.63	0.219	10.5	0.876	42.0
8	0.00945	0.406	0.0473	2.03	0.189	8.12	0.756	32.5
10	0.00845	0.332	0.0423	1.66	0.169	6.63	0.676	26.5
12	0.00770	0.272	0.0385	1.36	0.154	5.44	0.616	21.8
14	0.00725	0.234	0.0363	1.17	0.145	4.68	0.580	18.7
16	0.00690	0.208	0.0345	1.04	0.138	4.16	0.552	16.6
18	0.00670	0.163	0.0335	0.815	0.134	3.26	0.536	13.0
20	0.00660	0.177	0.0330	0.883	0.132	3.53	0.528	14.1

Health effects ELVs for frequencies in the range 100 kHz to 6 GHz for whole body averaged SAR: 0.4 Wkg<sup>-1</sup> and for localised SAR in the head and trunk averaged over 10 g contiguous tissue: 10 Wkg<sup>-1</sup>

## 10.4 How the application is used

The equipment is automated and controlled remotely by the operators. The mobile phone base station will adjust its output power according to the call traffic being carried subject to a maximum that is set in spectrum licensing conditions. This makes it difficult for the landlord to predict the actual output at any given time. Output frequencies are also set in spectrum licensing conditions.

Modifications to the installation and occasional maintenance work are carried out by sub-contractors appointed by the operators.

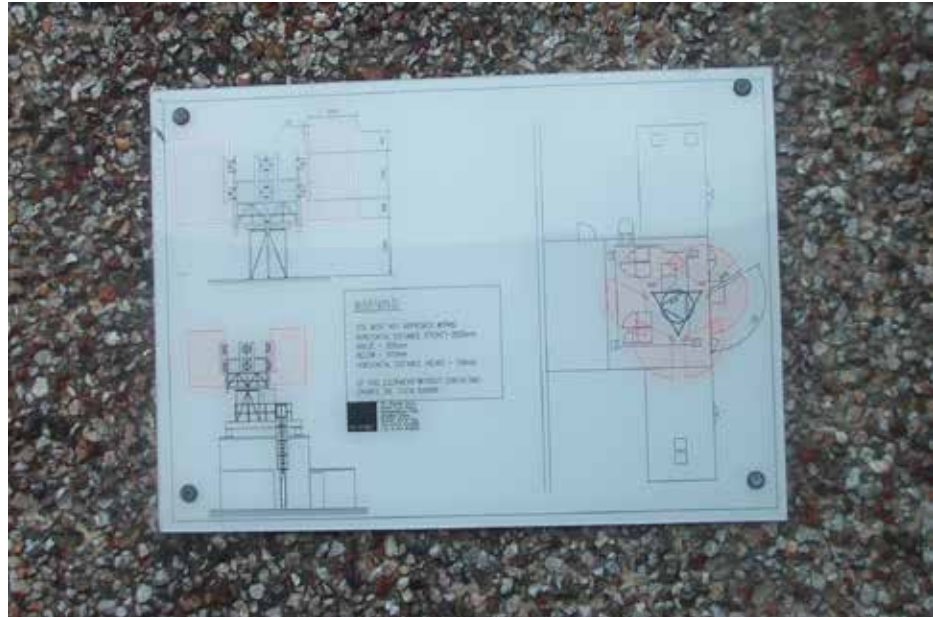
## 10.5 Approach to assessment of exposure

A detailed theoretical assessment of exposure would require information on a number of factors; including the type of antenna; the characteristics of the emission (e.g. frequency, radiated power, signal parameters, duty cycle, number of transmitted channels); the position of the worker in the radiation field; the duration of the exposure; and contributions from other sources.

It would also be possible to make measurements of exposures on the rooftop, although this would require the services of an expert consultant using specialised instrumentation. The landlord was aware that it would be possible to rent or buy an inexpensive instrument from the Internet, but that this might not give a reliable reading and might be sensitive to signals other than those of interest. The landlord was also aware that using the services of a consultant would be expensive and would only provide a snapshot of the exposure situation at the time of the measurements.

Instead, the landlord carried out a basic visual survey of the rooftop to identify the antennas and their operators and marked them onto a plan of the rooftop. Then the operators were contacted and required to visit the site to identify their antennas and provide related safety information. The landlord also examined the visitor's logbook to see who had accessed the rooftop and tried to determine by the nature of the work where they had been working. Using this information, locations were identified where it may be possible for workers to access hazardous field regions or exclusion zones (Figure 10.4). Good practice is for workers not to approach close to radiating antennas and potentially be exposed in excess of the action levels (ALs), and certainly they should not be able to touch radiating antennas.

**Figure 10.4 — Drawing showing the extent of the exclusion zones on the rooftop**



## 10.6 Results from exposure assessment

As a result of the visual survey and contact with the operators the landlord assembled a file of relevant safety information, which was subsequently made available to rooftop workers. This included a detailed antenna inventory of the following information: antenna type (e.g. sector antenna, microwave dish, folded dipole), operator, location (position, height, orientation), operating parameters, extent of any exclusion zone, date of installation (Table 10.2).

**Table 10.2 — Inventory of rooftop antennas assembled by the landlord**

Antenna type	Operator	Location on roof	Operating parameters	Exclusion zone	Date of installation
Mobile phone sector antennas (6 off)	Vodafone	Stub tower on roof of lift house 6 m level 0°, 120°, 240°	Frequency 2110-2170 MHz Power 56 dBm per signal 85° beam width Gain 17 dBi	2.5 m front 0.25 m rear 0.3 m above and below	June 2006
0.3 m microwave dish	Vodafone	Mounting pole on roof of lift house 5.5 m level 220°	Frequency 26 GHz Power 3 mW 1° beam width Gain 44.5 dBm	None	June 2006
Folded dipole	Pager Telecom	Close to walkway at entry onto roof 2 m level	Frequency 138 MHz Power 100 W Omni-directional Gain 2.15 dBi	2.5 m all around antenna	Unknown

## 10.7 Risk assessment

The landlord was aware of the requirement to assess all risks to workers accessing the rooftop (these could include the general risk of slips, trips and falls; of fumes from chimneys, stacks and vents; as well as the electromagnetic fields). The methodology suggested by OiRA (the EU-OSHA's online interactive risk assessment platform) was used to structure the process and in preparation for the assessment any information that was available from the operator or manufacturer of each antenna was identified. Quantitative information on the electric field strength from the antenna, or schematic diagrams showing the extent of any exclusion zones, allowed the landlord to carry out an evaluation of the level of risk. Where the accessible field exceeded the ALs then it was necessary to devise and implement an action plan to address the risks.

An example of an EMF specific risk assessment is shown in Table 10.3.

**Table 10.3 — EMF specific risk assessment for rooftop antennas**

Hazards	Existing preventive and precautionary measures	People at risk	Severity			Likelihood			Risk evaluation	New preventive and precautionary actions
			Minor	Serious	Fatal	Improbable	Possible	Probable		
Radiofrequency field direct effects	Door onto roof locked and key controlled	Window cleaners	✓				✓		Low	Relocate paging system antenna (folded dipole) away from walkway  Fit mechanical stop to ensure window cleaning cradle cannot be raised in front of sector antennas  Develop written safety procedure that all workers must read (and sign up to) before they are permitted to access rooftop
	Warning and prohibition notices	Roofing contractors	✓				✓		Low	
	Sector antennas mounted on upper reaches of lift house and associated exclusion zones inaccessible	Air conditioning engineers	✓				✓		Low	
	Ladder giving access to roof of lift house locked off	Insurance inspectors	✓				✓		Low	
	Dish antennas mounted high up on poles and beams inaccessible	Antenna riggers	✓				✓		Low	
		Workers at particular risk (pregnant workers)	✓				✓		Low	
Radiofrequency field indirect effects (interference with medical electronic equipment)	See above	Workers at particular risk		✓		✓			Low	See above. Warning for wearers of medical electronic equipment in written safety procedure

## 10.8 Precautions already in place

The landlord's visual survey of the rooftop revealed the following:

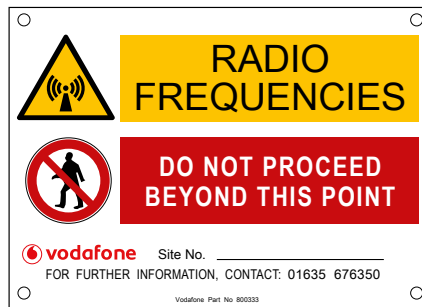
- the door onto the roof was locked and the key was controlled by the building security manager. A notice warning of the presence of radiofrequency antennas was fixed to the inside of the door (Figure 10.5a);
- the mobile phone sector antennas were mounted on the upper reaches of the lift house and the associated exclusion zones were inaccessible. Warning notices were fixed to the mounting poles (Figure 10.5b) and on the antenna casings (Figure 10.5c);
- the ladder giving access to the roof of the lift house was locked off and a warning was given (Figure 10.5d);
- the microwave dish antennas were mounted high up on the poles and their beams were inaccessible. (In any case the landlord has written evidence from the operator that there are no exclusion zones.).

**Figure 10.5 — Warning notices**

a) on the door onto the roof



b) on the mounting pole of the antenna



c) on the antenna casing



d) on the ladder onto the roof of the lift house





## 10.9 Additional precautions as a result of the assessment

The landlord was not content with some aspects of the way the rooftop installations were being managed and decided to implement additional precautionary measures, including:

- requiring the operator of a paging system to relocate the associated folded dipole antenna away from the walkway (Figure 10.6a) and to attach a warning notice (Figure 10.6b);
- fitting a mechanical stop to ensure that the window cleaning cradle cannot be raised in front of the sector antennas (Figure 10.6c);
- developing a written safety procedure that all workers must read (and sign up to) before they are permitted to access the rooftop. This includes contingency plans for reasonably foreseeable accidents and incidents.

**Figure 10.6**

a) paging antenna too close to the walkway



b) the new warning notice



c) the window cleaning cradle can no longer be raised in front of the antennas



# 11. WALKIE-TALKIES

## 11.1 Workplace

This case study concerns a small construction firm whose workers are based on building sites. The site foreman had heard about the new EMF Directive and was concerned whether the workers will have to take precautions when using walkie-talkies.

## 11.2 Nature of the work

Workers make contact with each other on site using walkie-talkies that operate using the unlicensed PMR (Private Mobile Radio) 446 service (Figure 11.1). The devices are available for use by all workers on site.

**Figure 11.1 — Site worker using a walkie-talkie**



After looking at the manufacturer's instructions, the foreman established that the hand-held devices operate around 446 MHz. However, there was no information in the instructions or EC Declaration of Conformity (Figure 11.2) the on the effective radiated power (ERP) or on suitable methods of use.

After searching on the Internet the foreman found information from the regulator of the service which stated that 'PMR 446 radio equipment must, be hand portable, have an integral antenna, have a maximum effective radiated power of 500 mW and be compliant with ETS 300 296'.

Figure 11.2 — EC Declaration of Conformity provided with the device

EC Declaration of Conformity

We the manufacturer / Importer

Declare under our sole responsibility that the following product

Type of equipment: Private Mobile Radio

Model Name: \_\_\_\_\_

Country of Origin: \_\_\_\_\_

Brand: \_\_\_\_\_

complies with the essential protection requirements of R&TTE Directive 1999/5/EC on the approximation of the laws of the Council Directive 2004/108/EC on the approximation of the laws of the Member States relating to *electromagnetic compatibility (EMC)* and the European Community Directive 2006/95/EC relating to *Electrical Safety*.

Assessment of compliance of the product with the requirements relating to the essential requirements according to Article 3 R&TTE was based on Annex III of the Directive 1999/105/EC and the following standards:


EMC&RF:

**EN 301-489-5 V1.3.1:(2002-08)**  
**EN 301-489-1 V1.8.1:(2008-04)**

**EN 300-296-1 V1.1.1:(2001-03)**  
**EN 300-296-2 V1.1.1:(2001-03)**  
**EN 300-341-1 V1.3.1(200012)**  
**EN 300-341-2 V1.1.1(200012)**

Electrical Safety:

**EN 60950-1:2006**

 Waste electrical products must not be disposed of with household waste. This equipment should be taken to your local recycling centre for safe treatment.

The product is labelled with the European Approval Marking CE as show. Any Unauthorized modification of the product voids this Declaration.

Manufacturer / Importer  
(signature of authorized person)

**CE**

Signature: ( \_\_\_\_\_ ) \_\_\_\_\_ London, \_\_\_\_\_

Signature: \_\_\_\_\_ Place & Date: 8th Aug, 2010

### 11.3 How the application is used

No training had been given to workers on use of the equipment. The foreman conducted an informal survey of usage position, which found that the walkie-talkies were held either in front of or to the side of the face. Also communications between workers were reported to be short generally no more than a few tens of seconds per transmission.

### 11.4 Approach to assessment of exposure

When assessing the exposure from transmitters located near the body, compliance with ELVs needs to be determined by computer modelling. Ideally this should be done by the manufacturer. However if this data is not available then an assessment can be made by referring to published information on similar devices. (It is also worth checking in Table 3.2 of Chapter 3 of Volume 1 of the guide to see whether the equipment is deemed to be a priori compliant with the EMF Directive.)

### 11.5 Results from exposure assessment

After phoning around government agencies, the foreman was told about published data from computer modelling performed for a similar device operating at similar frequencies (Dimbylow et al). This showed that the maximum specific energy absorption rate (SAR) over 10 g of contiguous tissue is  $3.9 \text{ Wkg}^{-1}$  per watt output power, for any possible operating position close to the face.

To assess against the health effects ELV for localised exposure in the head at this frequency ( $10 \text{ Wkg}^{-1}$ ) the exposure needs to be averaged over 6 minutes. As two way conversations are taking place the foreman assumed a maximum transmission duty cycle of 50 %. From the modelling data, the foreman was able to conclude that to exceed the ELV would require a device with an effective radiated power in excess of 5 W.

No information on the effective radiated power of the walkie-talkies was available from the manufacturer, but the regulator had already specified that the devices should not exceed 0.5 W output. The foreman was therefore able to conclude that exposure from the devices would not exceed the health effects ELVs in the EMF Directive.

### 11.6 Risk assessment

The results of the exposure assessment indicate that the use of the walkie-talkies will not exceed the relevant health effects ELVs in the EMF Directive. However there is a possibility that there could be interference with medical devices fitted to or worn by workers. Any workers with medical devices should be subject to an individual risk assessment where any precautions recommended by their medical consultant can be identified and implemented.

## 11.7 Precautions already in place

No precautions were already in place.

## 11.8 Additional precautions as a result of the assessment

The foreman decided to implement a few simple measures:

- workers were given a tool box talk that included when and how to use the walkie-talkie as well as recommended positions for holding the device;
- existing workers were asked to report if they were at particular risk, such as being fitted with a pacemaker;
- all new workers are now screened to see if they are at particular risk.

## 12. AIRPORTS

The sources of EMF in this case study include the following:

- airport surveillance radar,
- non-directional beacon,
- distance measuring equipment.

### 12.1 Workplace

The radar, non-directional beacon (NDB), and distance measuring equipment (DME) were in use at an international airport serving passenger and freight aircraft. The workplaces of interest at the airport were as follows:

- the radar equipment cabin, which housed the radiofrequency (RF) generator,
- the steel lattice tower on which the radar antenna was mounted,
- the air traffic control tower,
- the NDB equipment cabin, which housed the RF generator,
- the compound in which the NDB antenna was located,
- the airport fire station, which was situated close to the NDB,
- the DME cabin, which housed the RF generator,
- the area surrounding the DME cabin, on which the antenna was mounted.

### 12.2 Nature of the work

#### 12.2.1 Radar

The majority of work on the radar was carried out by air traffic engineers in the equipment cabin. These workers were also occasionally required to carry out work on the antenna. Other airport workers in the air traffic control tower, which was at a distance of approximately 80 m from the radar and of a similar height, may also have been exposed to RF radiation from the antenna and had expressed some concerns about this.

#### 12.2.2 Non-directional beacon

The majority of work on the NDB was carried out by engineers in the equipment cabin. These workers were also occasionally required to enter the NDB compound in order to tune the NDB to ensure that it meets the correct output specifications; this tuning was carried out in a cabinet located within a few metres of the antenna. The close proximity of the NDB to the airport fire station was also a cause of concern for the airport fire-fighters.

### 12.2.3 Distance measuring equipment

The majority of work on the DME was carried out by engineers in the equipment cabin. These workers were rarely required to work on the antenna itself, but other airport workers had expressed some concern that the antenna was only 2.5 m above the ground with no restriction of access.

## 12.3 Information on the equipment giving rise to EMF

### 12.3.1 Radar

The radar consisted of an RF generator, which produces pulses of RF radiation, and a rotating antenna. The RF generator was installed in an equipment cabin and the antenna was mounted on top of a steel lattice tower. The signal from the RF generator was carried to the antenna by a rectangular waveguide. An example of an airport surveillance radar is shown in Figure 12.1 and the technical specifications of the radar are shown in Table 12.1.

**Figure 12.1 — Example of an airport surveillance radar**



**Table 12.1 — Technical specifications of the airport surveillance radar**

Operating parameter	Value
Nominal transmit frequency	3 GHz
Nominal peak output power	480 to 580 kW
Nominal average output power	430 W
Pulse length	0.75 to 0.9 $\mu$ s
Pulse repetition frequency	995 Hz
Antenna rotation speed	15 rpm

### 12.3.2 Non-directional beacon

The NDB consisted of an RF generator, which produces a 343 kHz amplitude modulated RF signal with a maximum power of 100 W, and a self-supporting transmitter in the form of a 15 m tall lattice mast. The antenna was installed within a compound, which also contained a cabinet in which the tuning equipment was housed. The RF generator was installed in an equipment cabin outside the antenna compound.

### 12.3.3 Distance measuring equipment

The DME consisted of an RF generator and an antenna, which was mounted on the equipment cabin. The DME transmits pulses of RF radiation in response to signals received from aircraft approaching the airport. The RF signals are transmitted over a frequency range of 978 to 1213 MHz with a pulse length of 3.5  $\mu$ s. The interval between pulses is between 12 and 36  $\mu$ s.

## 12.4 How the applications are used

The radar, NDB and DME are automated and controlled remotely. Modifications to the equipment and occasional maintenance work are carried out by engineers, who may occasionally need access to the antennas. In each case, the RF generator is switched off whenever access to the antenna is required.

## 12.5 Approach to assessment of exposure

Measurements of exposures were made by an expert consultant using specialised instrumentation (a ridge guide receiving antenna connected to a spectrum analyser for providing a detailed assessment of the exposure from the pulsed radar signal at specific locations, and a three-axis RF hazard probe). The measurements were made in locations accessible to workers while the equipment was transmitting.

### 12.5.1 Radar

Because of the nature of radar signal transmission (the RF signal is made up of short pulses and the antenna rotates), the exposure at any one location is not continuous, and so it was necessary to carry out a detailed exposure assessment in terms of two quantities:

- peak power density, which is a measure of the exposure that a worker could receive from each individual pulse of the RF signal;
- average power density, which is calculated from the peak power density and is a measure of the exposure averaged over several minutes, taking account of the pulsed nature of the radar signal and the rotational period of the antenna.

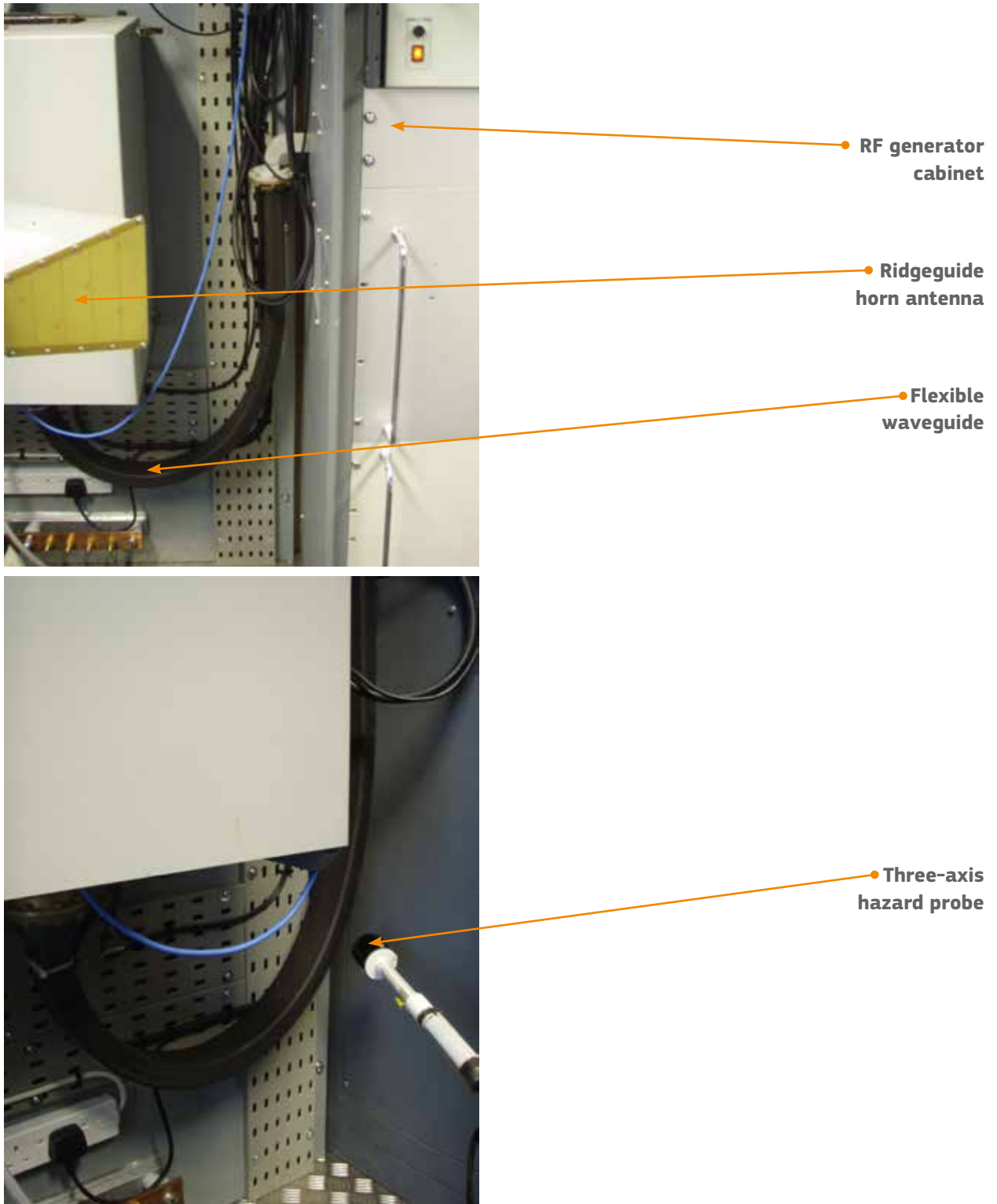
Measurements of power density were made at four locations in the air traffic control tower using the ridge guide antenna and spectrum analyser.

Measurements were also made of electric field strength in several locations using the RF hazard probe.

Measurements were made in the equipment cabin, on the antenna tower, close to the waveguide (paying particular attention to connecting flanges and any sections of flexible waveguide (Figure 12.2)), the air traffic control tower, and other areas around the radar that were accessible to workers, including those at particular risk.



Figure 12.2 — Measurements being made around a flexible waveguide in a radar equipment cabin



## 12.5.2 Non-directional beacon

Measurements of electric field strength were made using the RF hazard probe in locations accessible to workers around the NDB, paying particular attention to areas occupied by air traffic engineers and the airport fire-fighters.

## 12.5.3 Distance measuring equipment

Measurements of electric field strength were made using the RF hazard probe inside the equipment cabin and at the closest point of access to the antenna outside the cabin, which was representative of a worker reaching towards the antenna with their hand when standing at ground level.

## 12.6 Results from exposure assessment

The results of the measurements were compared with the relevant action levels (AL) and the significant findings of the exposure assessment are presented in Tables 12.2, 12.3 and 12.4. When assessing the exposure of workers at particular risk, comparison was made with the reference levels given in the Council Recommendation (1999/519/EC) (see Appendix E of Volume 1 of the guide).

**Table 12.2 — Summary of results of radar exposure assessment**

Location	Quantity measured	Result	Exposure fraction (percent)	
			Relevant action level <sup>1,2</sup>	1999/519/EC reference level <sup>3</sup>
Roof of ATC tower	Peak power density	33 000 Wm <sup>-2</sup>	66 %	<b>330 %</b>
	Average power density	0.012 Wm <sup>-2</sup>	0.024 %	0.12 %
Equipment cabin	Maximum electric field strength	< 0.1 Vm <sup>-1</sup>	< 0.1 %	< 0.2 %
10 cm from flexible waveguide outside equipment cabin		29 Vm <sup>-1</sup>	21 %	48 %
Torso position at closest access to antenna on antenna tower		31 Vm <sup>-1</sup>	22 %	51 %

<sup>1</sup> It was noted that no action levels have been provided in the EMF Directive for the power density of RF radiation at frequencies below 6 GHz, which is of particular relevance to pulsed RF signals, and so, in accordance with elicitation 15 of the EMF Directive, the consultant referred to the guidelines provided by the International Commission on Non-Ionizing Radiation Protection (ICNIRP) for the assessment of exposure to the pulsed RF radiation from the radar, as follows:

300 GHz: Occupational reference level for peak power density for pulsed RF radiation for frequencies in the range 2 to 300 GHz: 50 000 Wm<sup>-2</sup>  
Occupational reference level for average power density for frequencies in the range 2 to 300 GHz: 50 Wm<sup>-2</sup>

<sup>2</sup> Electric field strength action level for frequencies in the range 2 to 6 GHz: 140 Vm<sup>-1</sup>

<sup>3</sup> Council Recommendation (1999/519/EC) reference levels:

Peak power density for pulsed RF radiation for frequencies in the range 2 to 300 GHz: 10000 Wm<sup>-2</sup>,  
Average power density for frequencies in the range 2 to 300 GHz: 10 Wm<sup>-2</sup>,  
Electric field strength for frequencies in the range 2 to 300 GHz: 61 Vm<sup>-1</sup>.

*NB:* The uncertainty in the measurements was estimated to be ±2.7 dB and in accordance with the 'shared risk' approach (see Appendix D5 of Volume 1 of the Guide) the results were compared directly with the AL/RL.

**Table 12.3 — Summary of results of NDB exposure assessment**

Location	Maximum electric field strength ( $\text{Vm}^{-1}$ )	Exposure fraction (percent)		
		Low action level <sup>1</sup>	High action level <sup>2</sup>	1999/519/EC reference level <sup>3</sup>
Equipment cabin	100	59 %	17 %	120 %
Fire service crew room	< 0.1	< 0.1 %	< 0.1 %	< 0.2 %
Boundary fence of NDB compound	270	160 %	45 %	310 %

<sup>1</sup> Electric field strength low action level for frequencies in the range 3 kHz to 10 MHz:  $170 \text{ Vm}^{-1}$

<sup>2</sup> Electric field strength high action level for frequencies in the range 3 kHz to 10 MHz:  $610 \text{ Vm}^{-1}$

<sup>3</sup> Council Recommendation (1999/519/EC) reference level on electric field strength for frequencies in the range 150 kHz to 1 MHz:  $87 \text{ Vm}^{-1}$

*NB:* The uncertainty in the measurements was estimated to be  $\pm 2.7 \text{ dB}$  and in accordance with the 'shared risk' approach (see Appendix D5 of Volume 1 of the Guide) the results were compared directly with the ALs/RL.

**Table 12.4 — Summary of results of DME exposure assessment**

Location	Maximum electric field strength ( $\text{Vm}^{-1}$ )	Exposure fraction (percent)	
		Low action level <sup>1</sup>	1999/519/EC reference level <sup>2</sup>
Equipment cabin	< 0.1	< 0.2 %	< 0.3 %
2.5 m above ground level, 0.6 m from antenna	14	15 %	33 %

<sup>1</sup> Most restrictive electric field strength action level for frequencies in the DME transmission range of 978 to 1213 MHz:  $94 \text{ Vm}^{-1}$

<sup>2</sup> Most restrictive Council Recommendation (1999/519/EC) reference level on electric field strength for frequencies in the DME transmission range of 978 to 1213 MHz:  $43 \text{ Vm}^{-1}$

*NB:* The uncertainty in the measurements was estimated to be  $\pm 2.7 \text{ dB}$  and in accordance with the 'shared risk' approach (see Appendix D5 of Volume 1 of the Guide) the results were compared directly with the AL/RL.

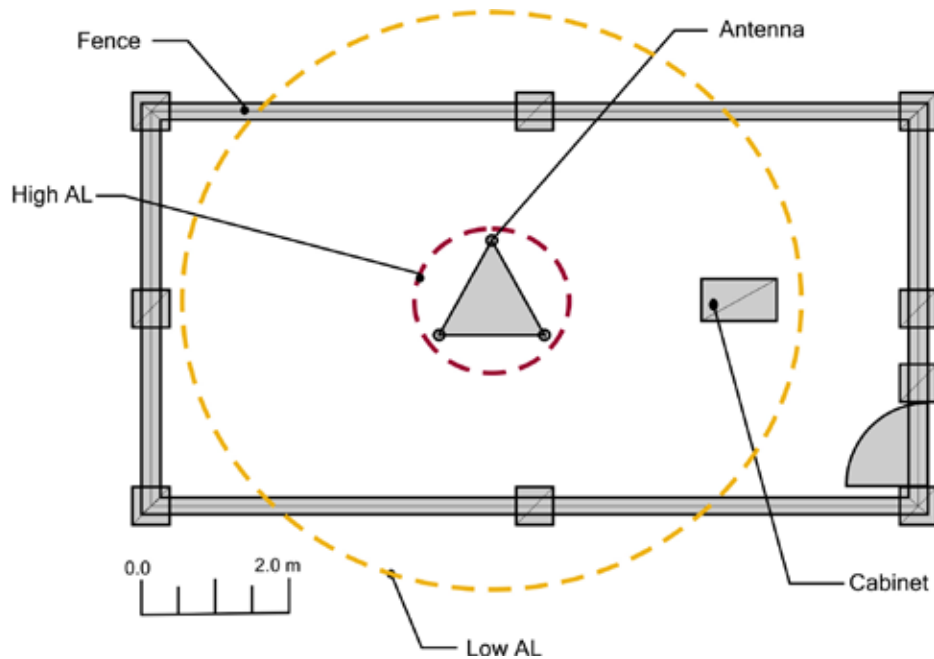
## 12.6.1 Radar

The results from the exposure assessment indicated that exposure to RF radiation from the radar was below the ALs in the EMF Directive. However, the assessment highlighted some areas in which the reference levels given in the Council Recommendation (1999/519/EC) were exceeded, although these areas were unlikely to be occupied by workers at particular risk.

## 12.6.2 Non-directional beacon

The results from the exposure assessment indicated that exposure to RF radiation from the NDB was above the electric field low AL (Figure 12.3) and above the reference levels given in the Council Recommendation (1999/519/EC) in areas outside the fence surrounding the NDB. These areas could be occupied by workers, including those at particular risk.

**Figure 12.3 — Plan view showing the contours within which the action levels could be exceeded around the non-directional beacon**



### 12.6.3 Distance measuring equipment

The results from the exposure assessment indicated that exposure to RF radiation from the DME was below the AL and below the reference levels given in the Council Recommendation (1999/519/EC) in all accessible areas surrounding the DME.

## 12.7 Risk assessment

The airport operator carried out risk assessments of the radar, NDB and DME based on the exposure assessment performed by the consultant. This was consistent with the methodology suggested by OiRA (the EU-OSHA's online interactive risk assessment platform). The risk assessment concluded that:

- workers at particular risk may encounter a hazard from the radar on the roof of the air traffic control tower;
- workers, including those at particular risk, had unrestricted access to areas around the NDB in which the low AL for sensory effects was exceeded, because the boundary fence had been installed too close to the transmitter;
- workers were unlikely to encounter a hazard in relation to the DME.

The airport operator developed an action plan from the risk assessments and this was documented.

Examples of EMF specific risk assessments for the radar, the NDB and the DME are shown in Tables 12.5, 12.6 and 12.7.



**Table 12.6 — EMF specific risk assessment for non-directional beacon**

Hazards	Existing preventive and precautionary measures	People at risk	Severity			Likelihood			Risk evaluation	New preventive and precautionary actions
			Minor	Serious	Fatal	Improbable	Possible	Probable		
Radiofrequency direct effects	Physical prevention of access to transmitter compound by unauthorised persons	Engineers	✓				✓		Low	Reposition boundary fence to encompass the entire area in which the electric field strength exceeds the low action level
	A simple procedure to ensure that the transmitter is switched off whenever close access to the antenna is required	Airport workers	✓				✓		Low	Provide specific warnings in site safety information  Display appropriate notices warning of the radiofrequency hazard at points of access to the NDB compound
	Notices warning of electric shock risk only	Workers at particular risk (including pregnant workers)	✓				✓		Low	Prepare a procedure for carrying out the tuning of the NDB  Provide RF safety awareness training to engineers who carry out tuning of the NDB signal
Radiofrequency indirect effects (interference with medical implants)	Notices warning of electric shock risk only  All workers instructed to inform the airport operator if they are fitted with a medical implant	Workers at particular risk	✓			✓			Medium	See above

**Table 12.7 — EMF specific risk assessment for distance measuring equipment**

Hazards	Existing preventive and precautionary measures	People at risk	Severity			Likelihood			Risk evaluation	New preventive and precautionary actions
			Minor	Serious	Fatal	Improbable	Possible	Probable		
Radiofrequency direct effects	A simple procedure to ensure that the transmitter is switched off whenever close access to the antenna is required	Engineers	✓			✓			Low	None
		Airport workers	✓			✓			Low	
		Workers at particular risk (including pregnant workers)	✓			✓			Low	
Radiofrequency indirect effects (interference with medical implants)	All workers instructed to inform the airport operator if they are fitted with a medical implant	Workers at particular risk		✓			✓		Low	None

## 12.8 Precautions already in place

### 12.8.1 Radar

A variety of protection and prevention measures were associated with the radar, including:

- the equipment cabin and antenna tower was enclosed within a compound surrounded by a secure perimeter fence;
- the door to the equipment cabin and the gate to the compound were locked when unattended, and access to the keys was restricted to authorised workers only;
- the staircase serving the antenna tower was locked behind a separate gate within the compound;
- warning notices (Figure 12.4) were attached to the gate of the radar compound and to the gate of the staircase serving the antenna tower;
- interlocks on the RF generator cabinet in the equipment cabin;
- a simple procedure to ensure that the RF generator is switched off whenever access to the antenna tower is required;
- a safeguard to ensure that the RF generator is switched off if the radar stops rotating;
- all airport workers were instructed to inform the airport operator if they are fitted with a medical implant.

**Figure 12.4 — Warning notices on the gate to the radar compound (left) and on the gate to the antenna tower (right)**



## 12.8.2 Non-directional beacon

Prior to the exposure assessment carried out by the consultant there were very few protection and prevention measures in place. These were limited to:

- a boundary fence around the transmitter;
- notices warning of the risk of electric shock were attached to the fence surrounding the NDB;
- a simple procedure to ensure that the RF generator is switched off whenever access to the antenna tower is required;
- all airport workers were instructed to inform the airport operator if they are fitted with a medical implant.

## 12.8.3 Distance measuring equipment

A simple procedure to ensure that the RF generator is switched off whenever close access to the antenna is required was in place prior to the exposure assessment.

## 12.9 Additional precautions as a result of the assessment

### 12.9.1 Radar

The existing protection and prevention measures ensured that exposures of airport workers were generally below the relevant ALs and reference levels given in the Council Recommendation (1999/519/EC) for the areas in which measurements were made. The only exception was the roof of the air traffic control tower, where workers at particular risk may encounter a hazard from exposure to the RF radiation emitted by the radar, although it was considered unlikely that such workers would be required to access this area.

As a result of the exposure assessment, the airport operator implemented some minor recommendations on the advice of the consultant:



- warning notices, incorporating the radiating antenna pictogram and the words 'Caution Non Ionising Radiation' were displayed on the door providing access to the roof of the air traffic control tower;
- airport workers were reminded of the importance of informing the airport operator if they have been fitted with a medical implant;
- warnings specifically relating to the non-ionising radiation hazards associated with the radar were incorporated into the site safety information.

Although not implemented in this case, it is worth noting that an additional protection measure known as 'sector blanking', in which the radar transmission is operated at reduced power for a predetermined rotational region, could be considered if an exposure assessment identifies a significant risk of exposure to RF radiation from a radar. This would involve programming the radar to reduce or switch off the power of the RF radiation for the period of its rotation during which the antenna is aimed towards the area of concern. However, the use of sector blanking must be considered very carefully and its benefits must be weighed against any risks associated with the lack of surveillance data that would result from the radar transmitting at a reduced power.

### 12.9.2 Non-directional beacon

The existing protection and prevention measures were found to be inadequate, and several new measures were put in place.

As a result of the exposure assessment, the airport operator implemented several recommendations on the advice of the consultant:

- the boundary fence surrounding the NDB was moved further away from the transmitter so that it accommodated the area in which the electric field strength exceeded the Low AL. It was noted that an alternative to moving the boundary fence would have been to provide training for workers who may be required to access the area, but repositioning the boundary fence was a simpler and more effective solution;
- warning notices, incorporating the radiating antenna pictogram and the words 'Caution Non Ionising Radiation' were displayed on the gate of the NDB compound;
- a procedure for carrying out the tuning of the NDB signal was developed;
- engineers who may be required to carry out tuning of the NDB inside the compound were provided with RF radiation awareness training;
- airport workers were reminded of the importance of informing the airport operator if they have been fitted with a medical implant;
- warnings specifically relating to the non-ionising radiation hazards associated with the NDB were incorporated into the site safety information.

### 12.9.3 Distance measuring equipment

- No further protection and prevention measures were implemented, as the existing measures were found to be adequate.





The Directive 2013/35/EU lays down the minimum safety requirements regarding the exposure of workers to risks arising from electromagnetic fields (EMF). This practical guide has been prepared to assist employers, particularly small to medium sized enterprises, to understand what they will need to do to comply with the Directive. However, it may also be useful for workers, workers representations and regulatory authorities in Member States. It consists of two volumes and a specific guide for SMEs.

The practical guide volume 1 provides advice on carrying out risk assessment and further advice on the options that may be available where employers need to implement additional protective or preventive measures.

Volume 2 presents twelve case studies that show employers how to approach assessments and illustrate some of the preventive and protective measures that might be selected and implemented. The case studies are presented in the context of generic workplaces, but were compiled from real work situations.

The guide for SMEs will assist you to carry out an initial assessment of the risks from EMF in your workplace. Based on the outcome of this assessment, it will help you decide whether you need to take any further action as a result of the EMF Directive.

This publication is available in electronic format in all EU official languages.

---

You can download our publications or subscribe for free at <http://ec.europa.eu/social/publications>

If you would like to receive regular updates about the Directorate-General for Employment, Social Affairs and Inclusion sign up to receive the free Social Europe e-newsletter at <http://ec.europa.eu/social/e-newsletter>

 <https://www.facebook.com/socialeurope>

 [https://twitter.com/EU\\_Social](https://twitter.com/EU_Social)